

XDCAM EX Clip Browsing Software

User's Guide Version 2.5

XDCAM EX

NOTICE TO USERS

Documentation © 2007-2009 Sony Corporation

All rights reserved. This manual or the software described herein, in whole or in part, may not be reproduced, translated or reduced to any machine readable form without prior written approval from Sony Corporation.

SONY CORPORATION PROVIDES NO WARRANTY WITH REGARD TO THIS MANUAL, THE SOFTWARE OR OTHER INFORMATION CONTAINED HEREIN AND HEREBY EXPRESSLY DISCLAIMS ANY IMPLIED WARRANTIES OF MERCHANTABILITY OR FITNESS FOR ANY PARTICULAR PURPOSE WITH REGARD TO THIS MANUAL, THE SOFTWARE OR SUCH OTHER INFORMATION. IN NO EVENT SHALL SONY CORPORATION BE LIABLE FOR ANY INCIDENTAL, CONSEQUENTIAL OR SPECIAL DAMAGES, WHETHER BASED ON TORT, CONTRACT, OR OTHERWISE, ARISING OUT OF OR IN CONNECTION WITH THIS MANUAL, THE SOFTWARE OR OTHER INFORMATION CONTAINED HEREIN OR THE USE THEREOF.

Sony Corporation reserves the right to make any modification to this manual or the information contained herein at any time without notice.

The software described herein may also be governed by the terms of a separate user license agreement.

Table of Contents

For Windows

| | |
|---|-----------|
| Introduction | 7 |
| Purpose of this manual | 7 |
| Notes on use of XDCAM devices | 7 |
| Overview | 7 |
| New functions supported in Version 2.5 | 7 |
| Hardware and software requirements..... | 7 |
| XDCAM devices supported by the application..... | 8 |
| Installing the Application | 8 |
| Installing from the CD-ROM | 8 |
| Launching and Exiting the Application | 9 |
| Launching the application | 9 |
| Exiting the application..... | 9 |
| Names and Functions of Parts | 10 |
| Operating window configuration..... | 10 |
| Explorer window | 12 |
| Preview window | 15 |
| Clip Operations | 18 |
| Copying clips..... | 18 |
| Moving clips..... | 20 |
| Deleting clips..... | 21 |
| Grouping clips that have been split across separate media | 21 |
| Creating clips by specifying ranges..... | 22 |
| Importing clips | 22 |
| Exporting clips | 23 |
| Previewing clips | 25 |
| Changing the index picture of a clip | 27 |
| Creating still images..... | 27 |
| Searching for clips..... | 27 |
| Folder and Media Operations | 29 |
| Folders for XDCAM EX clips..... | 29 |
| Folders for MXF clips | 29 |
| Creating folders | 29 |
| Deleting folders | 30 |
| Splitting folders | 30 |
| Combining folders..... | 31 |
| Checking/editing disc metadata..... | 32 |
| Appendix | 32 |
| How XDCAM EX clip data are configured | 32 |
| How MXF clip data are configured..... | 33 |

| | |
|--|----|
| User settings | 34 |
| Menu list..... | 36 |
| Error and warning message list | 42 |
| How to obtain the plug-in software | 44 |
| Licenses | 44 |

For Mac OS

| | |
|---|-----------|
| Introduction..... | 47 |
| Purpose of this manual | 47 |
| Notation for special keys | 47 |
| Notes on use of XDCAM devices | 47 |
| Overview | 47 |
| New functions supported in Version 2.5 | 47 |
| Hardware and software requirements..... | 47 |
| XDCAM devices supported by the application..... | 48 |
| Installing the Application | 48 |
| Installing from the CD-ROM | 48 |
| Launching and Exiting the Application | 50 |
| Launching the application | 50 |
| Exiting the application..... | 50 |
| Names and Functions of Parts | 51 |
| Operating window configuration..... | 51 |
| Explorer window | 52 |
| Preview window | 55 |
| Clip Operations | 59 |
| Copying clips..... | 59 |
| Moving clips..... | 61 |
| Deleting clips..... | 62 |
| Grouping clips that have been split across separate media | 62 |
| Creating clips by specifying ranges..... | 62 |
| Importing clips | 63 |
| Exporting clips | 64 |
| Previewing clips | 66 |
| Changing the index picture of a clip | 67 |
| Creating still images | 67 |
| Searching for clips..... | 68 |
| Folder and Media Operations | 69 |
| Folders for XDCAM EX clips..... | 69 |
| Folders for MXF clips | 69 |
| Creating folders | 69 |
| Deleting folders | 70 |
| Splitting folders | 71 |
| Combining folders..... | 71 |

| | |
|---|-----------|
| Checking/editing disc metadata..... | 72 |
| Appendix | 73 |
| How XDCAM EX clip data are configured | 73 |
| How MXF clip data are configured..... | 73 |
| User settings | 74 |
| Menu list..... | 77 |
| Error and warning message list | 82 |
| How to obtain the plug-in software | 84 |
| Licenses | 84 |

For Windows

How to use the application on Windows

Introduction

Purpose of this manual

This manual explains how to use the XDCAM EX Clip Browsing Software on Microsoft Windows. This manual is intended for users who will use this application to perform file and folder operations. It assumes that readers have a basic familiarity with Microsoft Windows.

Notes on use of XDCAM devices

- This software cannot access an XDCAM HD device while another XDCAM-compatible application (XDCAM Transfer/PDZ-1) is accessing that device.
- While running this software, if it becomes necessary to connect/disconnect the i.LINK cable or power on/off the XDCAM device, always do such operations after you exit this software.

Overview

The XDCAM EX Clip Browsing Software allows you to work with clips created with XDCAM EX/XDCAM HD devices.

After installing this application on your computer, you can use its intuitive graphical user interface to organize your clips by copying, moving, and deleting them. You can also perform format conversions, preview the clips, and view their metadata.

This application supports XDCAM EX/XDCAM HD compatible data.¹⁾

1) For XDCAM HD compatible data, executable operations are limited (*see next section*).

New functions supported in Version 2.5

The following table shows the principal new functions supported in Version 2.5.

| Function | Description | Reference |
|---|--|-----------|
| XDCAM HD file operations | You can operate on XDCAM HD files (MXF files). However, the operations are limited to copying, deleting, and previewing. | – |
| Converting EX files to MXF files by copying | You can convert XDCAM EX files (MP4 files) to MXF files by copying them to a folder with MXF attributes. | Page 19 |
| Extended export function | You can convert files to XDCAM MPEG IMX and XDCAM DVCAM format files. | Page 24 |

Hardware and software requirements

Install this application on a computer meeting the following hardware and software requirements.

| Item | Description |
|---------|--|
| OS | Microsoft Windows XP SP3 or higher (32-bit version), or Microsoft Windows Vista SP1 or higher (32-bit version) ^{a)} |
| CPU | Intel Pentium 4 2.0 GHz or higher (Intel Core 2 Duo Processor 2.0 GHz or higher recommended) ^{b)} |
| Memory | 1 GB or more (2 GB or more recommended) |
| Display | Resolution: 1280 x 1024 pixels or better |

| Item | Description |
|-------|--|
| Audio | Audio playback function |
| Other | Windows Desktop Search (WDS) ^{c)} |

- a) Microsoft, Windows, and Windows Vista are registered trademarks of Microsoft Corporation in the United States and other countries.
- b) Intel, Intel Core and Pentium are trademarks or registered trademarks of Intel Corporation or its subsidiaries in the United States and other countries.
- c) To use keyword searching on Windows XP, the latest version (Version 3.00 or higher) of Windows Desktop Search (WDS) must be installed. Keyword searching is not available if WDS is not installed or if the installed version is not the latest version. The WDS component is preinstalled on Windows Vista. It does not need to be installed again.

All product names and brand names are registered trademarks or trademarks of their respective owners.

XDCAM devices supported by the application

This application supports the following XDCAM devices:

| Series name | Model name |
|-------------------------------------|------------|
| XDCAM HD422 (Version 1.2 or higher) | PDW-700 |
| | PDW-740 |
| | PDW-HD1500 |
| XDCAM HD (Version 1.92 or higher) | PDW-F355L |
| | PDW-F335L |
| | PDW-F335K |
| | PDW-F75 |
| XDCAM HD Drive | PDW-U1 |

Installing the Application

If the MainConcept plug-in software is installed
Update the plug-in software to the latest version (*see page 44*).

You can use the extended export function of the XDCAM EX Clip Browsing Software Version 2.5.

If Version 1.0x is installed

Uninstall Version 1.0x (1.00 or 1.01) (*see page 9*) before you start the installer.

Installing from the CD-ROM

- 1 Insert the supplied CD-ROM into the CD-ROM drive of your computer.

The cover page appears automatically in your browser. If it does not appear, double click index.htm on the CD-ROM.

- 2 Select and click [Windows XP/Vista] from the XDCAM EX Clip Browsing Software Installer.

The folder where the setup application is stored appears.

- 3 Double click Setup.exe.

The setup wizard appears.



- 4 Click the [Next] button in the setup wizard.

A license agreement screen appears.

- 5 Click the [Accept] button, and then click the [Next] button.

The following screen appears.

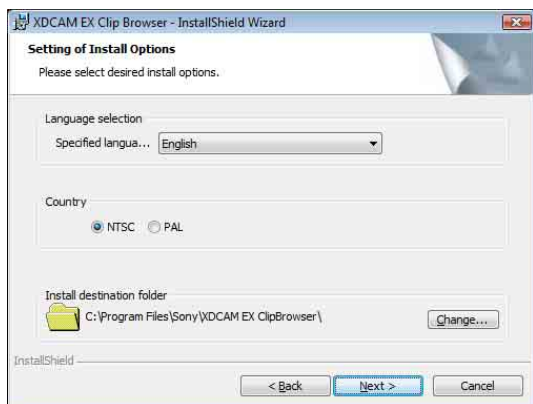

- 6** Change the settings as required, and then click the [Next] button.

To change the installation destination

Click the [Browse...] button and select the folder in the dialog that appears.

Complete the installation by following the instructions on the screen.

The following screen appears when the installation finishes.

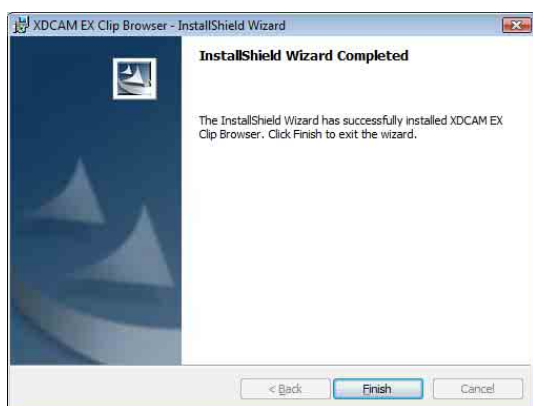

- 7** Click the [Finish] button to close the dialog.

To uninstall the application

Select Add or Remove Programs in the Windows Control Panel, and then select and delete [XDCAM EX Clip Browser] from the list of installed programs.

Note

Uninstalling the application also uninstalls the MainConcept plug-in software at the same time.

Launching and Exiting the Application

See “Installing the Application” (page 8) for more information about how to install the application.

Launching the application

Double click the shortcut icon on the desktop. The XDCAM EX banner appears, the application starts, and the operating windows (see page 10) appear.

Note

It is not possible to launch more than one instance of this application at one time.

Exiting the application

Do one of the following.

- Select [Exit] from the [File] menu.
- Click the x button in the upper right of the operating window.

Note

Do not power off the computer while a file operation is still underway. Files may be corrupted. Wait until the operation finishes, or cancel the operation, before powering off.

Names and Functions of Parts

Operating window configuration

The following figure shows the default configuration of the operating windows.

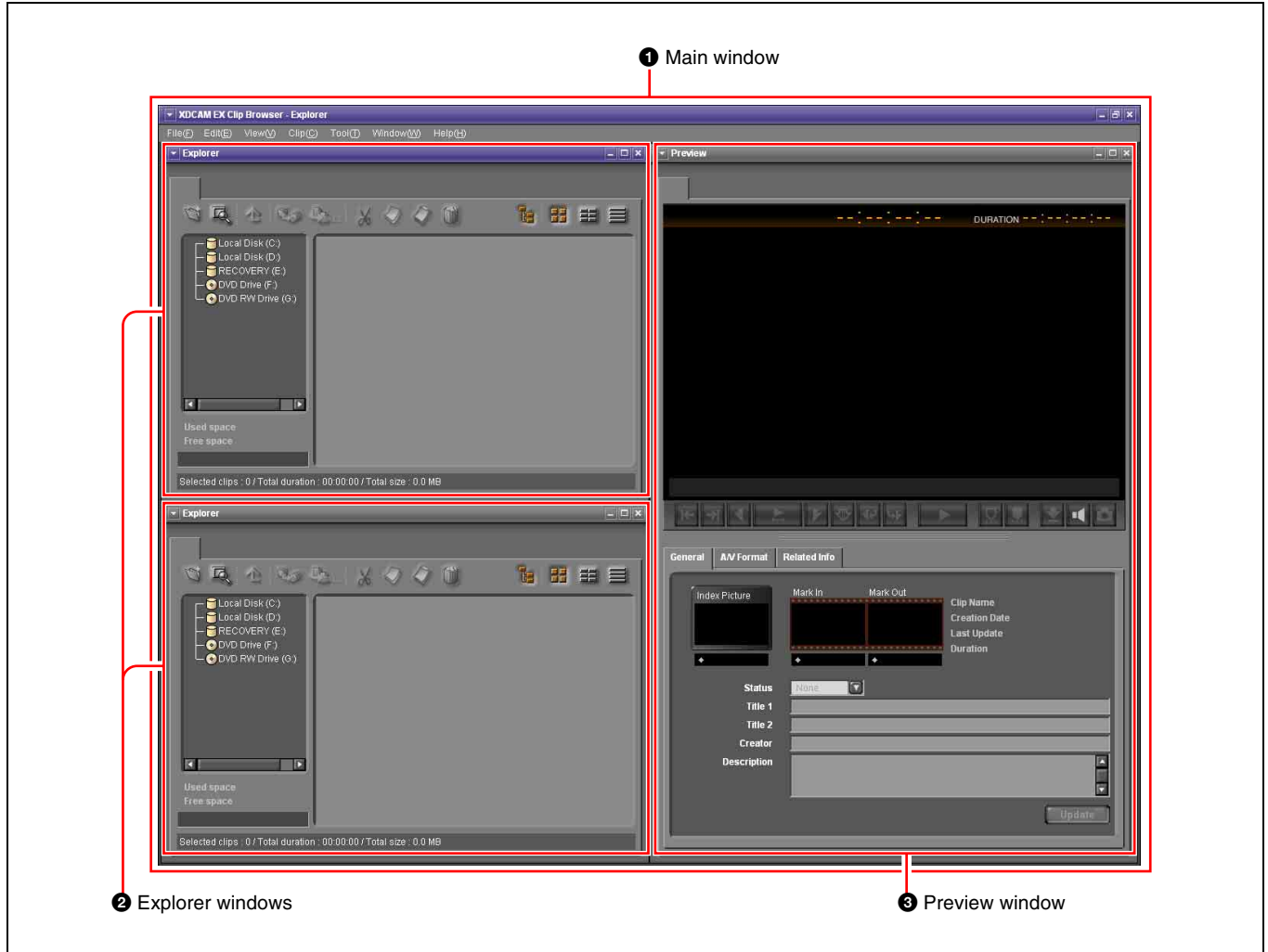

1 Main window

This is the main window of the application. It contains Explorer windows and Preview windows. The title bar displays the name of this application, followed by the title of the active window inside the main window frame (Explorer or Preview). The menu and menu items in the menu bar change depending on the window inside the main window frame (or the active window, when more than one window is open).

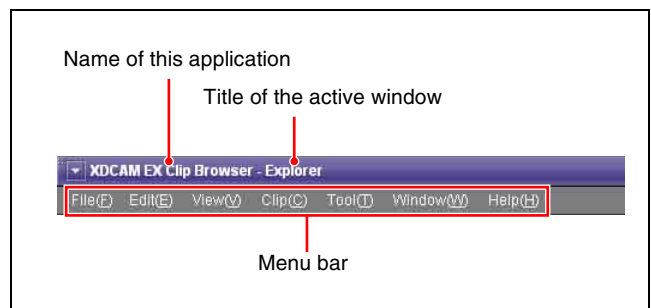

2 Explorer windows

You can have up to ten Explorer windows open at one time. When you have more than one window open, you can convert them into tabs on one window.

For details, see “Explorer window” (page 12).

3 Preview windows

You can have up to five Preview windows open at one time. When you have more than one window open, you can convert them into tabs on one window.

For details, see “Preview window” (page 15).

To customize the window configuration

To open another window

Select [New Explorer Window] or [New Preview Window] from the [Window] menu. A new Explorer or Preview window opens.

To tab windows

You can convert windows of the same type (Explorer or Preview) into tabs in a single window. To tab a window, drag it and drop it on another window.

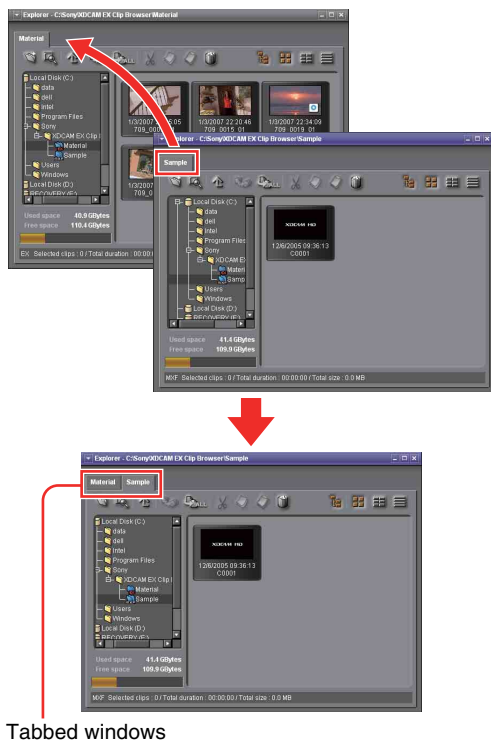

To convert a tabbed window back into a separate window

Drag the tab of the window that you want to separate away from the other window.

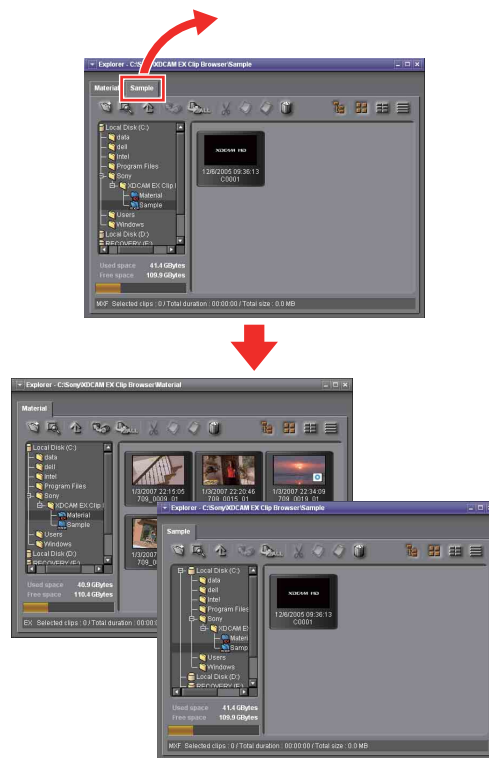

Other window operations

- Drag the window title bar to move a window.
- Resize a window by dragging on any window border.
- Click a maximize button in the upper right corner of a window to maximize it.
- Close a window you do not need by clicking the x (close) button in the upper right corner.

The application remembers your most recent configuration and recreates it the next time it starts.

To optimize the window configuration

Select [Optimize Window Layout] from the [Window] menu. This optimizes the positions of Explorer and Preview windows in the main window.

Keyboard shortcuts for selecting windows and tabs

You can use keyboard shortcuts to select windows and tabs.

To select the next window from the keyboard

Hold down the Ctrl key and press the Tab key. (This manual refers to this operation as “press Ctrl + Tab”.) The next window is selected with each key press. You can select the next window in reverse order by pressing Ctrl + Shift + Tab.

When one Preview window is already open, you can open a new Preview tab by doing one of the following in an Explorer window.

- Double click a media file in the List View pane.
- Select a media file in the List View pane, and then select [Play] from the [Clip] menu.

If the selected media file is already loaded into its own Preview window or a Preview tab, that window or tab is activated.

To select the previous or next tab from the keyboard

Press **Ctrl + PageUp**, or **Ctrl + PageDown**.

Explorer window

Explorer windows are where you operate on clips (files) and folders, and where you check clip metadata. You can operate on XDCAM EX/XDCAM HD format folders and media.

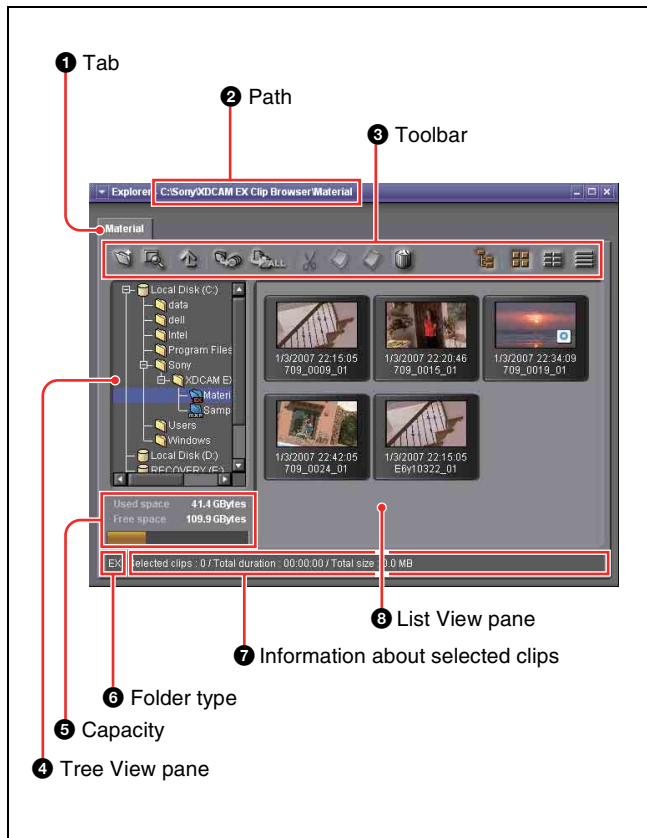

1 Tab

The tab displays the name of the media or folder that is selected in the Tree View pane.

When two or more Explorer windows are open, you can drag and drop the tab on another window to convert this window into a tab on the other window (*see page 11*).

2 Path

This is the full path to the media or folder that is selected in the Tree View pane.

3 Toolbar

Contains tool buttons for operations on clips and folders.











4 Tree View pane

| Tool buttons | | Function | Reference |
|--------------|--------------------------|---|--------------------|
| Icon | Name | | |
| | New Folder | Creates a new folder in the currently selected media or folder. | Page 29 |
| | Find | Opens the Find dialog. | Page 27 |
| | Up | Moves up to the next higher folder. | – |
| | Split Folder | Opens the Split Folder dialog. | Page 30 |
| | Copy All | Copies all of the clips in the selected media or folder to a new folder. This application creates the new folder automatically. | Page 20 |
| | Cut | Cut the selected clip. | Page 20 |
| | Copy | Copy the selected clip. | Page 18 |
| | Paste | Pastes a clip that has been cut or copied. This can be used to move a clip to another media or folder. | Page 18 Page 20 |
| | Delete | Delete the selected clip or folder. | Page 21 Page 30 |
| | Folder Tree Display/Hide | Shows or hides the Tree View pane. | – |
| | Thumbnails | Puts the List View pane into thumbnails view mode. | – |
| | Clip List | Puts the List View pane into list view mode. | – |
| | Details | Puts the List View pane into details view mode. | – |

4 Tree View pane

Displays a tree of media and folders located beneath My Computer.

The following icons represent the type of the media or folder.

| Icon | Type of media or folder |
|---|--|
|  | Hard disk drive |
|  | CD, DVD or Blu-ray Disc drive |
|  | XDCAM drive (normal) |
|  | XDCAM drive (UserData) |
|  | SxS memory card drive |
|  | Mass storage device (removable drive) connected by USB |
|  | Mounted network drive |
|  | Normal folder, not managed by this application |
|  | Folder with EX attributes |
|  | Folder with MXF attributes |

The Tree View pane supports the same kinds of operations as the tree panel of Windows Explorer.

You can show or hide folder contents by clicking the Folder Tree Display/Hide button on the toolbar.

Notes

- When you select a media item, a message may appear saying that salvage is required, and that you should salvage the media on the device that recorded it. This message appears when the data is defective, typically because the XDCAM EX device was powered off or the media was ejected too soon during recording. If this message appears, you should reinsert the media into the XDCAM EX device and attempt to salvage it as soon as possible. The data may become unrecoverable if you continue to work with it without salvaging it.
- Depending on the Windows desktop theme, some characters may fail to appear in list view. But this has no effect on operations by this application.

Media

In this manual, “media” refers to the following media types.

- SxS memory cards
- USB memory
- Internal hard disks
- Externally connected hard disks
- CD-R discs
- DVD-R discs
- Blu-ray discs
- Professional Discs (XDCAM drives)

5 Capacity

Displays the used capacity and remaining capacity of the media selected in the Tree View pane.

The remaining capacity is shown as a numeric value and as a bar graph. The orange bar grows longer as more of the media’s capacity is used.

6 Folder type

Displays the type of the folder being selected in the Tree View pane.

EX: Folder with EX attributes

MXF: Folder with MXF attributes

7 Information about selected clips

Displays information about the clips that are selected in the List View pane (number of selected clips, total clip length, and total size).

Note

The total clip length is an approximate value, so take it as an approximate guide.

8 List View pane

Displays the clips in the media or folder that is selected in the Tree View pane. You can select from the following three view modes.

Thumbnail View: This view displays the index picture of each clip (or a thumbnail of the first frame, when no index picture is set). It also displays the name of the clip and the date and time when the clip was shot.

List View: This view displays an icon indicating the type and current state of the clip, and the name of the clip.









Details View: This view displays an icon indicating the type and current state of the clip, the name of the clip, and its properties.







To switch the clip view mode

Do one of the following.

- Select [Thumbnails], [List], or [Details] from the [View] menu.
- Click the Thumbnails, List, or Details button in the toolbar.

A mark for the clip status is displayed on the thumbnail or icon in all of the view modes.

| View mode | Icon | Description |
|----------------------|---|---|
| List or Details view |  | Normal MP4 file |
| |  | MP4 file with OK status (as set on the XDCAM EX device) ^{a)} |
| |  | An MP4 file in which some of the video cannot be displayed. However, other parts of the video can be previewed, and the properties of the MP4 file can be edited like the properties of normal MP4 files. |
| |  | Abnormal MP4 file (without data, cannot be decoded, etc.) |
| |  | Normal MXF file |
| |  | MXF file with OK status (as set on the XDCAM device) ^{a)} |
| |  | An MXF file in which some of the video cannot be displayed. However, other parts of the video can be previewed, and the properties of the MXF file can be edited like the properties of normal MXF files. |
| |  | Abnormal MXF file (without data, cannot be decoded, etc.) |

| View mode | Thumbnail display example | Description |
|-----------------|---|--|
| Thumbnails view |  | Normal clip |
| |  | Clip with OK status (as set on the XDCAM EX device) ^{a)} |
| |  | Part of a clip that spans several media discs or memory devices. ^{b)} |
| |  | A clip in which some of the video cannot be displayed. However, other parts of the video can be previewed, and the properties of the clip can be edited like the properties of normal clips. |
| |  | A clip that cannot be loaded. The clip cannot be previewed, and its properties cannot be edited. ^{c), d)} |
| |  | A clip that cannot be loaded. The clip cannot be previewed, and its properties cannot be edited. ^{c), d)} |

- a) Clips with OK status can be moved or deleted by this application.
b) XDCAM EX devices automatically save video that exceeds 4 GB in size as multiple clips. These clips are parts of the complete recording and can be saved on multiple media. Not all of the original recorded video is played back when a split clip is played back.
c) A clip that cannot be played or displayed properly by this application. The file may be corrupt, file links may be broken or changed, required files may be missing, or thumbnail creation may have failed.
d) A clip that cannot be played or displayed properly by this application. Another application is using the clip file.

To sort the Details View list

Click the header of the column that you want to use as the sort key.

Each click sorts the list again in ascending or descending order.

You can also sort by selecting one of the following items under [Sort By] in the [View] menu.

- Clip Name
- Size
- Duration
- Status
- Creation Date
- Last Update
- Recording Mode
- Media Spanning

To select the items to display in Details View

Open the dialog shown below by selecting [Customize Columns...] from the [View] menu, and then proceed as follows.

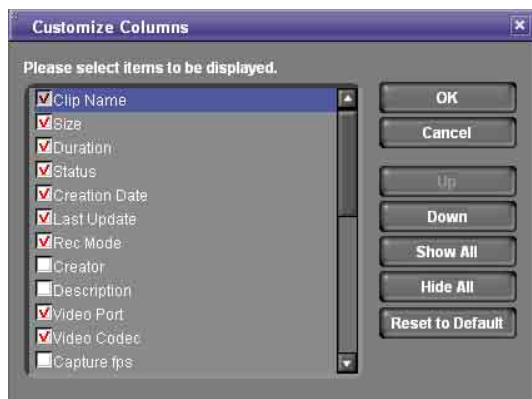

To select an item to display: Check the check box. You can click the [Show All] button to check all of the check boxes.

To select an item to hide: Clear the check box. You can click the [Hide All] button to clear all of the check boxes except "Clip Name".

To change the display order: Click an item to highlight it, and click the [Up] or [Down] button.

To return to the default settings: Click the [Reset to Default] button.

To confirm the changes: Click the [OK] button.

To cancel the changes: Click the [Cancel] button.

Preview window

Preview windows are where you preview clips and check clip information.

Notes about the Preview window

Playback in this window is preview playback. Note the following points.

- Depending on the performance of your computer and the processing load, dropped frames may occur, timecode may differ from the actual values, the clip may not be played smoothly, and some time may be required before the screen is updated.
- When the playback clip is defective, video breakup may occur and the playback may freeze.
- Not all of the original recorded video is played back when a split clip is played back.
- It may not be possible to play clips created on devices other than XDCAM EX devices.
- Improper playback may occur if the screen properties of your computer are changed during playback. If this occurs, restart the application.

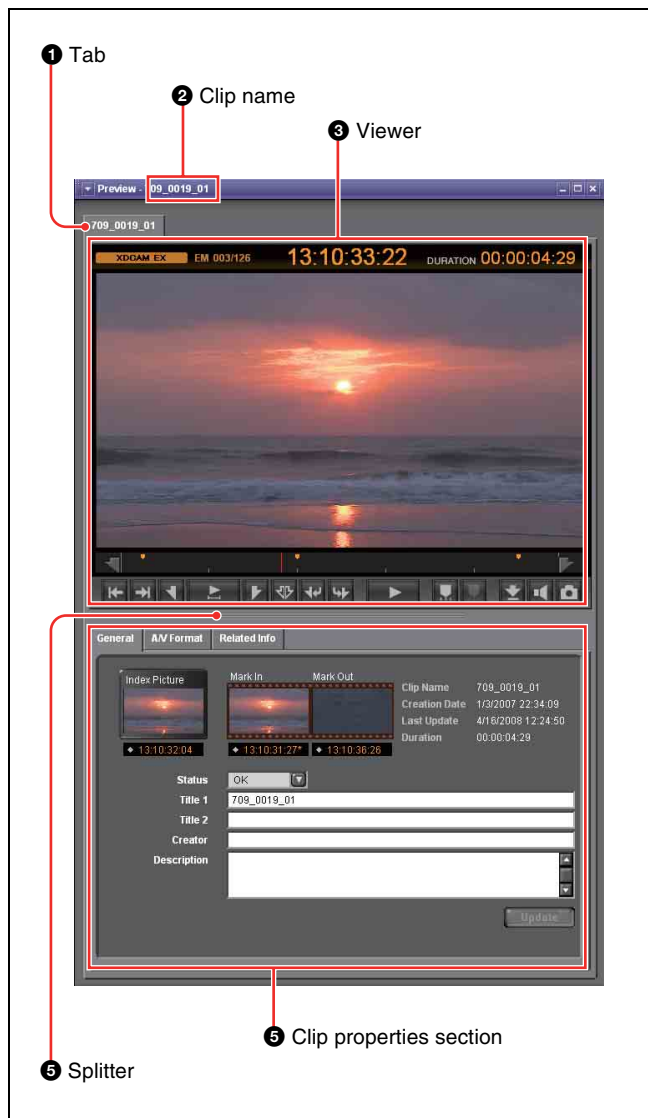

1 Tab

Displays the clip name.

When two or more Preview windows are open, you can drag and drop the tab on another window to convert this window into a tab on the other window (*see page 11*).

2 Clip name

Displays the clip name of the selected tab.

3 Viewer

Previews clips (*see next section*).

4 Splitter

You can drag the splitter up and down to change the relative sizes of the viewer and the clip properties section.

5 Clip properties section

Allows you to check clip properties (*see page 17*).

Viewer

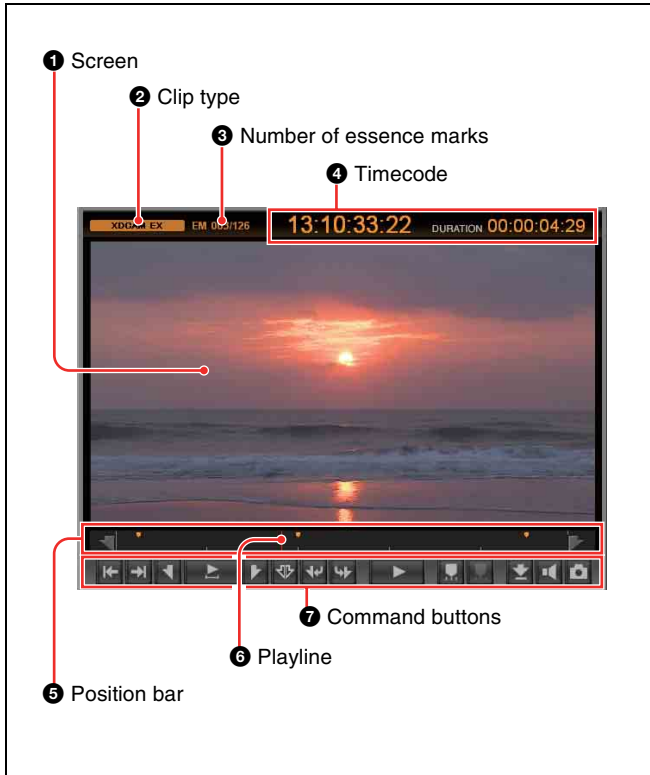

1 Screen

Displays the playback video.
 You can double click the screen or select [Full Screen] from the [View] menu to enlarge the size to full screen size.
 To return to the original size, double click the screen again or press the Esc key.

2 Clip type

Displays the type of the clip being viewed on the viewer.
XDCAM EX: XDCAM EX clip (MP4 file)
XDCAM HD/HD422: MPEG HD file created from XDCAM HD or XDCAM HD422 clip (MXF file)
XDCAM HD Proxy: Proxy file created from XDCAM HD or XDCAM HD422 clip (MXF file)

3 Number of essence marks

Displays the number of the essence marks set in the clip (in the format of: actually set number/maximum allowable number).

4 Timecode

Displays the timecode of the current position (playline position), and the duration of the section between In and Out points in the clip. A counter value is displayed when no timecode is recorded in the clip.
 For NTSC clips, a period (.) between the minutes and seconds of the current position indicates drop-frame, and a colon (:) indicates non-drop-frame.
 It is possible to jump to a specified position by clicking the current position timecode, entering a numeric value, and

pressing the Enter key. (This operation is ignored when invalid timecode is entered.)

You can change the timecode display format. For details, see "User settings" (page 34).

5 Position bar

Displays the time scale of the clip.
 The following marks are shown on the position bar to provide information about the clip.

| Mark | Meaning |
|------|---|
| | In point |
| | Out point |
| | Essence mark |
| | Timecode break point (discontinuous timecode) |

6 Playline

Displays the current position on the time scale.
 You can drag the playline or click anywhere on the position bar to move to a desired position. Scrubbing (repeatedly dragging to the left and right) is also supported.

7 Command buttons

These buttons perform various clip preview operations.
 The functions of these buttons can also be accessed from the keyboard.

| Icon | Button name | Keyboard operation | Function |
|------|-----------------------|--------------------|---|
| | Jump to Start | Home | Jumps to the clip start point (first frame). |
| | Jump to End | End | Jumps to the clip end point (last frame). |
| | Mark In ^{a)} | I | Sets an In point at the current position. Can be done during play (play continues). |
| | Play In to Out | Shift + Space | Plays the section from the In point to the Out point. (During play, the button icon lights green.) Stops play if clicked during play. |

| Icon | Button name | Keyboard operation | Function |
|------|-----------------------------------|--------------------|--|
| | Mark Out ^{a)} | O | Sets an Out point at the current position. Can be done during play (play continues). |
| | Clear Mark In/Out ^{a)} | Shift + X | Clears In and Out point settings. Can be done during play (play continues). |
| | Jump to In point | ↑ | Jumps to the In point. |
| | Jump to Out point | ↓ | Jumps to the Out point. |
| | Play | Space | Plays the clip. (During play, the button icon lights green.) Stops play if clicked during play. |
| | Add Essence Mark ^{a)} | E | Adds an essence mark at the current position. ^{b)} Can be done during play (play continues). However, an essence mark cannot be set at a position where one already exists. |
| | Delete Essence Mark ^{a)} | Shift + E | Deletes the essence mark at the current position. Can be done during play (play continues). |
| | Set Index Picture | P | Sets the current frame as the index picture of the clip. Can be done during play (play stops). |
| | Set Audio Channels | – | Opens the Set Audio Channels dialog. |

| Icon | Button name | Keyboard operation | Function |
|------|---------------------|--------------------|--|
| | Capture Still Image | – | Saves the frame at the current position as a bitmap file. This command opens a dialog where you can specify the file name and save destination. However, still images cannot be created from a clip on XDCAM disk. |

- a) You cannot use these buttons to apply editing operations on clips existing on the XDCAM drive. These buttons cannot add or delete edit points (In/Out points) or essence marks in those clips.
- b) The maximum number of essence marks that you can set in a single clip is as follows, depending on the clip format.
- XDCAM EX clip: 126
 - XDCAM HD clip (less than 126 seconds): the number of seconds + 1 (for example, 46 marks for a 45-second clip)
 - XDCAM HD clip (126 seconds or more): 126

Clip properties section

General tab

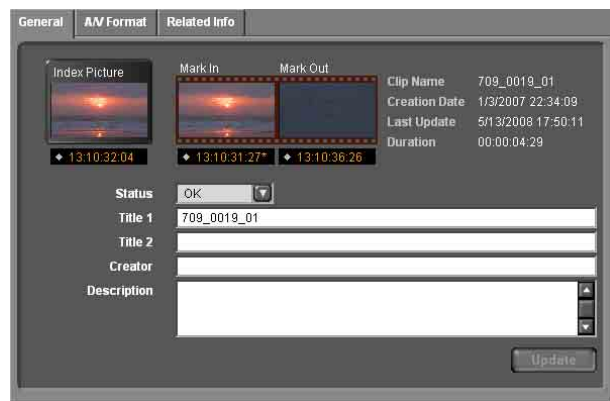

This tab displays general information about the clip.

- **Index Picture:** Displays the index picture of the clip, or a thumbnail of the first frame if no index picture has been set.
- **Mark In:** Displays a thumbnail of the In point, or a thumbnail of the first frame if no In point has been set.
- **Mark Out:** Displays a thumbnail of the Out point, or a thumbnail of the last frame if no Out point has been set.
- **Clip Name**
- **Creation Date** (date and time of creation)
- **Last Update** (date and time of most recent update)
- **Duration** (clip length)
- **Status:** Displays the clip status. You can select the status from among OK, NG, KEEP, and None.
- **Title 1:** Allows you to assign a title up to 63 ASCII bytes in length.
- **Title 2:** Allows you to assign a subtitle up to 127 bytes in length.

- **Creator:** Allows you to enter the name of the person who shot the clip, up to 127 bytes in length.
- **Description:** Allows you to enter a description of the scene depicted in the clip, up to 2047 bytes in length.

To save changes to the Status, Title 1, Title 2, Creator, and Description fields, you must click the Update button. The changes are discarded if you close the window or tab without clicking the Update button.

A/V Format tab

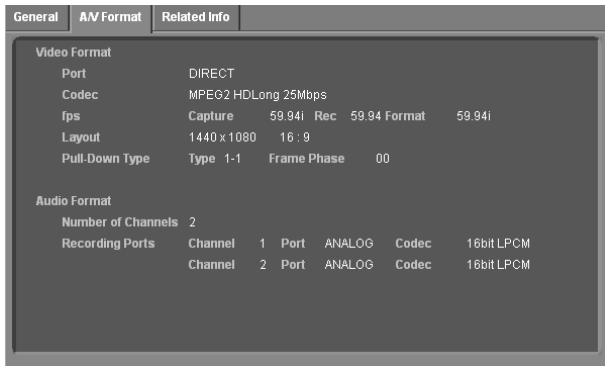

This tab displays information about the recording format of the clip.

- Video Format
- Audio Format

Related Info tab

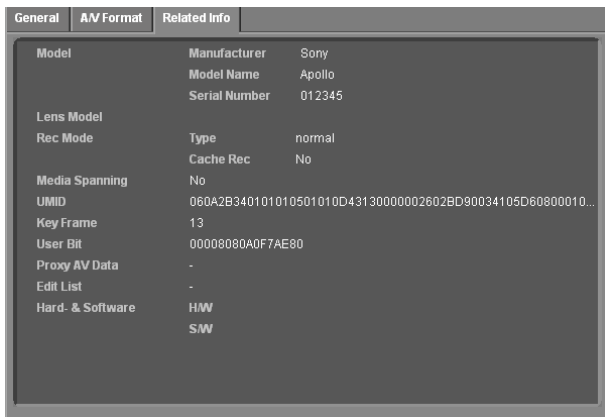

This tab displays information related to clip recording conditions.

- Model
- Lens Model
- Recording Mode
- Media Spanning
- UMID
- Key Frame
- User Bit
- Proxy AV Data
- Edit List
- Hard- & Software

Clip Operations

Clip operation precautions

- Always observe the following precautions during processing of clip operations.
 - Do not power off the computer or media drive before the operation completes.
 - Do not use Windows Explorer or another file management tool to delete folders that contain the clips being processed.
 - Do not eject the media before the operation completes.
- It may be possible to copy and move clips to media with this application even when the display on an XDCAM EX device indicates that the media is full. However, it will not be possible to play back or delete those clips when the media is inserted into the XDCAM EX device again (a message will appear saying that the media must be salvaged).
- For the folders created on a hard disk or other media by copying from XDCAM drive with Windows Explorer or other folder management tool, editing operations such as adding and deleting of clips cannot be performed.
- When writing clips to XDCAM drive, it is necessary beforehand to set the NAMING FORM option in the XDCAM HD device menu to “free (no format).” If the option is set to “C**** (standard format),” any clip with an arbitrary name other than C**** cannot be written to XDCAM drive.
- Writing a 50p or 60p frame rate clip to XDCAM drive moves the essence marks and Out points at the odd frames to the previous or next even frames. For example, the essence mark at the 15th frame moves to the 14th, while the Out point at the 19th frame moves to the 20th. However, the Out point will be deleted if an essence mark already set at the move destination frame.

For details about the menu operations of the XDCAM HD device, refer to the Operating Instructions or Operation Manual supplied with the XDCAM HD device.

Copying clips

You can duplicate clips on your media or computer, and copy clips between media and the computer.

Note

When copying MXF clips to XDCAM drive or a folder with MXF attributes, it is not possible to copy the clip of a different recording format from that of the clips in the destination.

Grouping split clips by gathering them into one place

XDCAM EX devices automatically save video that exceeds 4 GB in size as multiple clips. If you collect these clips into one media or folder, they are automatically grouped so that you can handle them as a single clip.

See “Grouping clips that have been split across separate media” (page 21) for more information.

To copy selected clips

- 1 Select a clip to copy in the List View pane of an Explorer window.

Notes

- Abnormal clips can be selected, but they are not copied.
- The folder that contains the selected clips cannot be specified as the copy destination.

If you want to copy the clips to a new folder

Create a new folder in the copy destination media or folder.

See “Creating folders” (page 29) for more information about how to create folders.

- 2 Do one of the following.

- Drag the clips selected in step 1 and drop them in the List View pane of another window, or on a copy destination media or folder in the Tree View pane of the same window or another window.
- Click the Copy button. Then click the List View pane of another window, or a copy destination media or folder in the Tree View pane of the same window or another window, and click the Paste button of that window.
- Select [Copy] from the [Edit] menu. Then click the List View pane of another window, or a copy destination media or folder in the Tree View pane of the same window or another window, and select [Paste] from the [Edit] menu.

A message appears asking if you want to execute the copy.



- 3 Click the [Yes] button to execute the copy, or the [No] button to cancel it.

A dialog illustrating the progress of the copying opens when the copying starts.

Note

Once it has been completed, you cannot undo the copy operation.

To cancel the copy operation

Click the [Cancel] button in the progress dialog.

Reasons why a copy operation may fail

Copy operations may fail for the following reasons. In these cases, an error message appears and the copy is not executed.

- There is not enough free capacity at the copy destination.
- A clip with the same name as one of the selected clips already exists at the copy destination. Even if the clip names are different, clips are recognized as the same clip if they share the same ID (UMID).
- You do not have delete/write privileges to the destination media or folders.
- The destination media or folder is write protected.

If you copy an XDCAM EX file to a copy destination with MXF attributes

Copying an XDCAM EX file (MP4 file) to XDCAM drive or an MXF folder automatically converts the file to the XDCAM HD format (MXF file). This makes EX material available on your XDCAM HD device more easily than the export function (see page 23).

Copied files have the same recording format as that of the existing files in the destination.¹⁾ However, the bit rates are determined as specified in [Bit Rate] under [MP4 to MXF conversion by copy] in the Conversion tab of the User Configuration dialog (see page 35).

1) If no file exists in the destination, the bit rate is determined as specified in [Format Settings: when there's no clip in the folder] under [MP4 to MXF conversion by copy] in the Conversion tab of the User Configuration dialog.

Supplement

When the [Convert in MXF for copying EX to a normal folder] check box in the General tab of the User Configuration dialog (see page 34) is checked, even the files which are to be copied to a normal folder are converted to the MXF format. Since the clip management folders for the XDCAM HD device (see page 33) are automatically created, the files converted in this application can be viewed. (The files which were output to a normal folder by the export function cannot be viewed in this application.)

Notes

- It is not possible to convert the XDCAM HD files to the XDCAM EX format.

- File conversion is not possible depending on the combination of source format and target format.
- File conversion may degrade the image quality.
- This copy operation takes longer to complete since it requires format conversion.
- XDCAM EX to XDCAM HD format conversion produces only MPEG HD files as MXF files. It does not produce Proxy files.

To copy all the clips in media or folders

You can copy all of the clips in a folder or a media disc or card in a single operation. This is a convenient way to import all the clips in an SxS memory card to the hard disk of your computer.

- 1 In the Tree View pane of an Explorer window, select the media or folder that contains the clips you want to copy.
- 2 Do one of the following.
 - Click the Copy All button.
 - Select [Copy All] from the [Edit] menu.

A message appears asking if you want to execute the copy. Check the destination folder.

You can change the copy destination folder. See “User settings” (page 34) for more information.

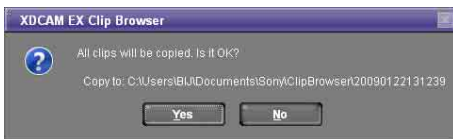

- 3 Click the [Yes] button to execute the copy, or the [No] button to cancel it.

A dialog illustrating the progress of the copying opens when the copying starts.

To cancel the copy operation

Click the [Cancel] button in the progress dialog.

Reasons why a copy operation may fail

Copy operations may fail for the following reasons. In these cases, an error message appears and the copy is not executed.

- There is not enough free capacity at the copy destination.
- A clip with the same name as one of the selected clips already exists at the copy destination. Even if the clip names are different, clips are recognized as the same clip if they share the same ID (UMID).
- You do not have delete/write privileges to the destination media or folders.
- The destination media or folder is write protected.

Copy error check option

For greater copy reliability, you can enable the CRC (cyclic redundancy check) error check option. However, copy operations take longer to complete when this option is enabled.

See “User settings” (page 34) for more information about this option.

Moving clips

You can move clips on your media or computer, and move clips between media and the computer.

Notes

- You cannot operate clips in other than XDCAM EX format (for example, XDCAM HD clips). You can operate XDCAM EX clips only.
- Clips with OK status can be moved by this application.

Grouping split clips by gathering them into one place

XDCAM EX devices automatically save video that exceeds 4 GB in size as multiple clips. If you collect these clips into one media or folder, they are automatically grouped so that you can handle them as a single clip.

See “Grouping clips that have been split across separate media” (page 21) for more information.

Move modes

You can specify whether to give priority to processing speed or to data protection when moving clips.

- Processing speed: Normal move processing, without creating a duplicate of the clip.
- Data protection: A duplicate of the clip is created before the original clip is deleted.

See “User settings” (page 34) for more information about the settings.

- 1 Select a clip to move in the List View pane of an Explorer window.

Notes

- Abnormal clips can be selected, but they cannot be moved.
- The folder that contains the selected clips cannot be specified as the move destination.

If you want to move the clips to a new folder

Create a new folder in the move destination media or folder.

See “Creating folders” (page 29) for more information about how to create folders.

2 Do one of the following.

- Drag the clips selected in step 1, and while holding down the Shift key, drop them in the List View pane of another window, or on a copy destination media or folder in the Tree View pane of the same window or another window.
- Click the Cut button. Then click the List View pane of another window, or a copy destination media or folder in the Tree View pane of the same window or another window, and click the Paste button of that window.
- Select [Cut] from the [Edit] menu. Then click the List View pane of another window, or a copy destination media or folder in the Tree View pane of the same window or another window, and select [Paste] from the [Edit] menu.

A message appears asking if you want to execute the move.



3 Click the [Yes] button to execute the move, or the [No] button to cancel it.

A dialog illustrating the progress of the move opens when the move starts.

Notes

- Once it has been completed, you cannot undo the move operation.
- Do not exit this application during the move. Doing so can break the links between clips and their metadata. The link information for split clips can be lost, causing them to become abnormal clips. If the selected clips are important, we recommend that you set the move mode to data protection mode (see page 20).

To cancel the move operation

Click the [Cancel] button in the progress dialog.

Reasons why a move operation may fail

Move operations may fail for the following reasons. In these cases, an error message appears and the move is not executed.

- There is not enough free capacity at the move destination.
- A clip with the same name as one of the selected clips already exists at the move destination. Even if

the clip names are different, clips are recognized as the same clip if they share the same ID (UMID).

- You do not have delete/write privileges to the source or destination media or folder.
- The source or destination media or folder is write protected.

Deleting clips

Notes

- Clips with OK status can be deleted by this application.
- Deleting a clip linked to edit lists deletes all the edit lists linked to the clip.

1 In the List View pane of an Explorer window, select a clip to delete.

2 Do one of the following.

- Press the Delete key.
- Click the Delete button.
- Select [Delete] from the [Edit] menu.

A message appears asking if you are sure you want to delete the clips.



3 Click the [Yes] button to execute the deletion, or the [No] button to cancel it.

Note

It is not possible to undo the deletion once it has been completed.

Reasons why a delete operation may fail

Deletion operations may fail for the following reasons. In these cases, an error message appears and the deletion is not executed.

- You do not have delete/write privileges to media or folder where the clips are stored.
- The media or folder where the clips are stored is write protected.

Grouping clips that have been split across separate media

When you have split clips that have been saved on separate media as a result of an extended recording session, you can group those clips by collecting them in a single location.

Grouped clips can be handled as a single clip. You can collect split clips by copying them, by moving them, or by combining split folders.

See “Copying clips” (page 18), “Moving clips” (page 20), and “Combining folders” (page 31) for more information about the operations.

Notes

- You cannot operate clips in other than XDCAM EX format (for example, XDCAM HD clips). You can operate XDCAM EX clips only.
- Split clips which are not continuous along the time axis are not grouped.
- Abnormal clips are not grouped.
- Clips with altered UMIDs are not grouped. Grouping is performed on the basis of the UMIDs of split clips, and not on the basis of their file names.

Creating clips by specifying ranges

You can create a new clip by setting In and Out points in an existing clip. The new clip can be handled in the same way as the original clip. This is a convenient way to create clips during online editing.

Note

You cannot operate clips in other than XDCAM EX format (for example, XDCAM HD clips). You can operate XDCAM EX clips only.

- 1 Preview a clip in a Preview window (see page 25), click the Mark In button at the position you want to use as the first frame, and click the Mark Out button at the position you want to use as the last frame.

In and Out points are set in the clip.

Supplement

You can also set the Out point by specifying the In point and duration. Duration can be specified by clicking the timecode display of the duration, entering a numeric value, and pressing the Enter key.

Note

In and Out points cannot be set at the same frame. When you try to set an Out (or In) point at a frame where an In (or Out) point has been set, the Out point is automatically set at the next frame after the In point.

- 2 Play the section specified in step 1, and adjust the In point and Out point positions as required.

- 3 In the List View pane of an Explorer window, find the clip where you set the In and Out points, and click the clip to select it.

To create several clips in one batch operation

You can create several clips in one operation. Carry out steps 1 and 2 in several clips stored in the same folder or on the same media, and then select those clips here.

- 4 From the [Clip] menu, select [New clip using In/Out section].

A confirmation message appears asking if you want to create the clips.



If the In and Out points are not set

The following message appears. If you choose to continue, the effect is the same as copying the complete original clip.

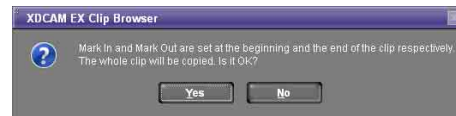

- 5 Click the [Yes] button to create a new clip, or the [No] button to cancel the operation.

A progress dialog opens when creation of the clip starts.

To cancel creation of the clip

Click the [Cancel] button in the progress dialog.

Reasons why a new clip operation may fail

Creation of a new clip may fail for the following reasons. In these cases, an error message appears and the clip is not created.

- There is not enough free capacity at the clip creation destination.
- You do not have delete/write privileges to the destination media or folders.

Importing clips

You can import XDCAM EX format compatible MP4 files and register them as clips that can be handled by XDCAM EX devices.

Note

You cannot operate clips in other than XDCAM EX format (for example, XDCAM HD clips). You can operate XDCAM EX clips only.

- 1 In the Tree View pane of an Explorer window, select the media or folder that contains the MP4 files to be imported.
- 2 Do one of the following.
 - Select [Import...] from the [File] menu.
 - Right click the media or folder and select [Import...] from the context menu.

The Import dialog opens.

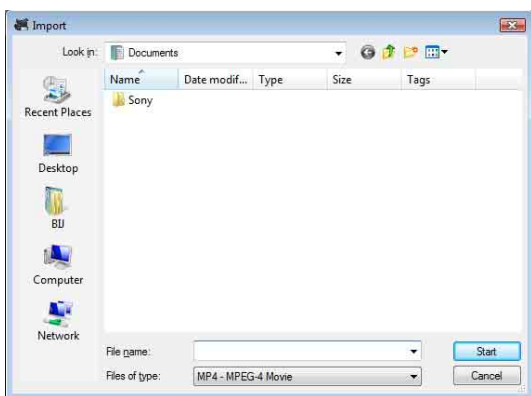

- 3 Select MP4 files to import.
- 4 Click the [Start] button to start the import, or the [Cancel] button to cancel it.

A dialog illustrating the progress of the import operation opens when the import starts.

To cancel the import operation

Click the [Cancel] button in the progress dialog.

Reasons why an import operation may fail

File import operations may fail for the following reasons. In these cases, an error message appears and the files are not imported.

- You do not have delete/write privileges for the import destination media or folder.
- The import destination media or folder is write protected.

Notes

- The properties of imported clips are set automatically.
- The format of imported clips is not fully compatible with the XDCAM EX format. It may not be possible

to play imported clips on XDCAM EX devices and with this application.

Exporting clips

You can export files created on XDCAM EX devices for use in various other environments. (To export is to convert files into other formats and output them.)

Future versions will support additional video formats. For upgrade information, visit the website listed in the “Features” section of the Operating Instructions for your XDCAM EX device and on the cover page of the supplied CD-ROM.

Note

You cannot operate clips in other than XDCAM EX format (for example, XDCAM HD clips). You can operate XDCAM EX clips only.

- 1 In the List View pane of an Explorer window, select a clip to export by clicking them.
- 2 Do one of the following.

- From the [File] menu, select [Export] and then select the format that you want to convert to.
- Right click the clip, from the context menu, select [Export] and then select the format that you want to convert to.

See “File conversion formats” (page 24) for more information about the available conversion formats.

An export dialog opens for the selected format. (The figure below shows the dialog that opens when you choose [MXF for XDCAM HD422].)

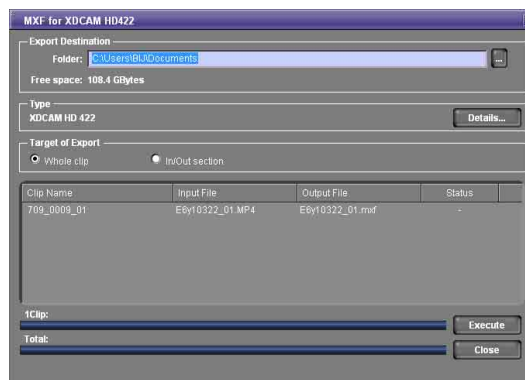

- 3 Change the following settings as required.

Export to: Specifies the export destination folder.

Enter a path beginning with a drive name in the edit box. Or click the [...] button to open a browse dialog where you can select a folder, and then click the [OK] button.

Note

Make sure that the export destination media has adequate free space before you execute the export. An error occurs at the point where the free space is used up.

Type: Click the [Details...] button to open the Codec Detail dialog, set parameters as required, and then click the [OK] button. This item does not appear for some conversion formats.

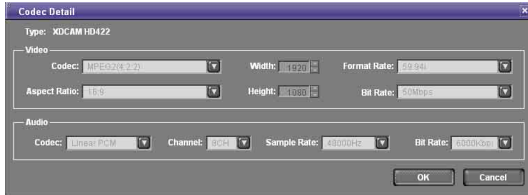

When “ICH” is selected in the [Channel] list box of the [Audio] section, a mixed signal of the channels 1 and 2 is output.

Target of Export: Select [In/Out section] if you want to output the range between the In and Out points in the current clip. This item does not appear for some conversion formats.

To change the output file name

In the List View pane, do one of the following to make the file name changeable.

- Click the file name.
- Right click the highlighted part to display the context menu and select [Modify the output filename] from the context menu.

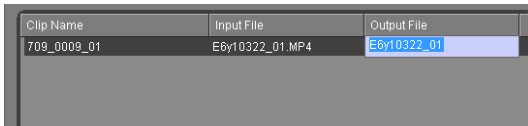

Enter a new name, and press the Enter key or click anywhere other than the file name. Extension does not need to be entered.

4 Click the [Execute] button to start the export.

A progress bar appears to show the progress of the export. The progress also appears in the [Status] column of the List View pane.

To cancel the export

Click the [Cancel] button.

If a file with the same name already exists at the output destination

A dialog appears to ask how you want to proceed. Read the explanation in the dialog and click one of the buttons.

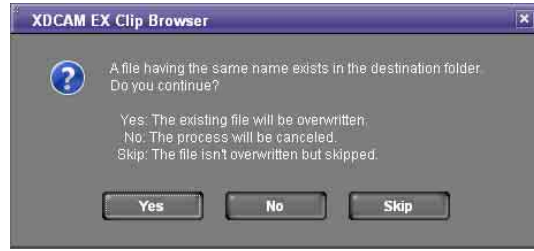

Notes

- The optional MainConcept plug-in software must be installed to use some conversion formats (see page 44). If the plug-in is not installed, a watermark appears in the exported video, and audio is saved for the first 30 seconds only (the subsequent audio is muted).
- Depending on the specified parameters, image quality may be degraded due to the image compensation process.
- Converted files may not be exactly the same with native files in the target format.
- Video metadata may not be inherited after format conversion.
- Image quality may be degraded if format conversion requires re-encoding.
- Image quality may be degraded and duration may vary if files are converted to a format with a different bit rate, resolution, or frame rate parameters.
- Before exporting, ensure that the export destination media or folder is write enabled.

File conversion formats

File conversion formats can be selected with the Export subcommands in the following table.

| Export subcommand | Extension after conversion | Description |
|---------------------------------------|----------------------------|--|
| MXF for NLEs ^{a)} | mxf | Converts to MXF file format without changing the bit rate, resolution or other parameters. This is for non-linear editors that support MXF files only. |
| MXF for XDCAM HD ^{b), c)} | mxf | Converts to an MXF format that is compatible with MXF files recorded by XDCAM HD devices. |
| MXF for XDCAM HD422 ^{b), d)} | mxf | Converts to an MXF format that is compatible with MXF files recorded by XDCAM HD422 devices. |
| MXF for XDCAM MPEG IMX ^{e)} | mxf | Converts to an MXF format that is compatible with MXF files recorded by XDCAM MPEG IMX devices. |

| Export subcommand | Extension after conversion | Description |
|------------------------------------|----------------------------|--|
| MXF for XDCAM DVCAM ^{e)} | mxf | Converts to an MXF format that is compatible with MXF files recorded by XDCAM DVCAM devices. |
| Raw DV | dv | Converts to RAW DV format. This is for DV format editing. Depending on the editing environment, use either this subcommand or the [AVI DV] subcommand. |
| AVI DV | avi | Converts to AVI Type-2 format. This is for DV format editing. Depending on the editing environment, use either this subcommand or the [RAW DV] subcommand. |
| Avid AAF ^{f)} | AAF/mxf | <p>Converts to the following two file formats.</p> <p>AAF file: Use to load clips into Avid editing system. The extension is AAF, and the output destination is the media or folder specified in the Export dialog (see page 23). AAF files produced by the conversion can be registered in your Avid editing system project by dragging from Windows Explorer to a bin in the project.</p> <p>MXF OPAtom file: The extension is mxf, and the output destination is the media or folder specified in the Conversion tab of the User Configuration dialog (see page 35). Normally this is the media folder of your Avid editing system project.</p> <p><i>For details, refer to the user's manual of your editing system.</i></p> |
| Windows Media File | wmv | Converts to Windows Media Player 9 compatible format. |
| Sony PSP (H.264/AVC) ^{g)} | mp4 | Converts to a format that allows clips to be previewed on the PlayStation Portable (PSP) game console from Sony Computer Entertainment. |

| Export subcommand | Extension after conversion | Description |
|--------------------------------------|----------------------------|--|
| Apple iPod (H.264/AVC) ^{g)} | mp4 | Converts to a format that allows clips to be previewed on the iPod portable media player from Apple Inc. |
| Video hosting service | wmv | Converts to a format optimized for Internet video hosting services. |

- a) When outputting the range between the In and Out points in the current clip, the duration may be prolonged after conversion.
- b) Clips of two seconds or less can be converted to MXF files, but they cannot be written to export destination devices.
- c) 23.98p clips can only be converted to a format with the same frame rate (23.98p).
- d) 23.98p clips cannot be converted.
- e) This application supports copying, deleting, and viewing properties of XDCAM MPEG IMX or XDCAM DVCAM clips. It does not support previewing and the other operations. Thumbnail creation fails.
- f) Avid editing systems may refuse to import a clip that has already been exported to the editing system.
- g) Improper playback may occur if the converted file is viewed on a viewer other than the specified devices.

Previewing clips

You can preview clips in the Preview window.

Several limitations apply to playback in the Preview window. For details, see “Notes about the Preview window” (page 15).

To load clips in the Preview window

Display the clip that you want to preview in the Clip View pane of an Explorer window, and then do one of the following.

- Double click the clip.
- Click the clip and then press the Enter key.
- Drag and drop the clip on a Preview window (this operation is disabled if multiple clips are selected).
- Right click the clip and select [Play] from the context menu.
- Click the clip and then press the space key.

The clip is loaded into a Preview window (and, when the fourth or fifth operation as stated above has been done, the playback starts). The timecode of the current playback position (or a counter value) appears in the upper part of the screen, together with the duration of the section between In and Out points in the clip.

To stop play

Click the play button.

Note

Smooth playback is not possible when previewing clips saved to DVD-R or CD-R discs.

To control the preview

You can use the following methods to control playback in the Preview window.

- Use the command buttons (*see page 16*) in the Viewer window.
- Select an operation from the [Play] menu.
- Drag the playline.
- Press the J, K, or L key.
 - J:** Change the reverse playback speed. Each press selects -1, -2, -4, -8, or -16 times normal speed.
 - K:** Stop playback.
 - L:** Change the forward playback speed. Each press selects 1, 2, 4, 8, or 16 times normal speed.

Note

No audio is output in playback at speeds greater than ± 4 times normal speed.

To select full-screen playback

Double click the screen, or select [Full Screen] from the [View] menu.

To return to the original screen size, double click the screen or press the Esc key.

To change the playback mode of MXF clips

Select “MPEG HD (high resolution)” or “Proxy (low resolution)” in the Play tab of the User Configuration dialog (*see page 35*).

Selecting “MPEG HD” makes it possible to preview with high definition images when the screen size is enlarged.

Notes

- You cannot change the playback mode when a clip is being played.
- Clips without proxy AV data are played at a high resolution regardless of this setting.
- Clips on XDCAM drive are played at a low resolution regardless of this setting.
- High resolution data may not be played smoothly due to its large file size.

To select the audio channels to monitor during previews

In the Set Audio Channels dialog, check the L (left) or R (right) check box to monitor that channel.

To open the Set Audio Channels dialog, do one of the following.

- Select [Set Audio Channels...] from the [Play] menu.
- Click the Set Audio Channels button.

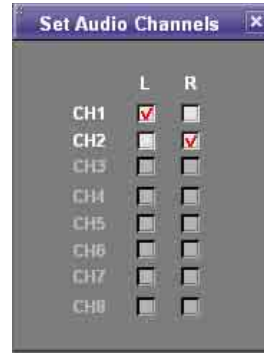
**To edit essence marks**

Use the Edit Essence Marks dialog.

To open the Edit Essence Marks dialog, load a clip into a Preview window, activate the Preview window, and select [Edit Essence Marks...] from the [Edit] menu.

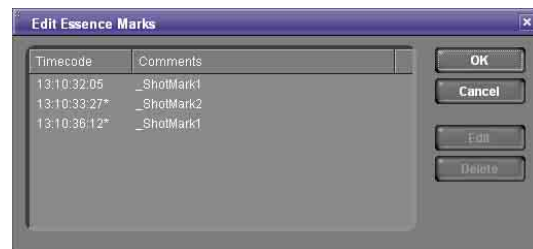
**Note**

Essence marks in clips on XDCAM drives cannot be edited.

To edit a comment: Select an essence mark in the list and click the [Edit] button. This opens the Edit Comments dialog. Edit the comment in the dialog and click the [OK] button. The maximum length of comments is 32 bytes. The edited comment appears in the Comment field of the Edit Essence Marks dialog.



To delete an essence mark: Select an essence mark in the list (you can select multiple essence marks by selecting with the Ctrl or Shift key held down) and press the [Delete] button.

To confirm changes: Click the [OK] button in the Edit Essence Marks dialog.

To discard changes: Click the [Cancel] button in the Edit Essence Marks dialog.

Notes

- The only essence marks that can be displayed on XDCAM EX devices are “_ShotMark1” and “_ShotMark2”.
- During playback on XDCAM EX devices, essence marks set by this application are displayed next to the frames where they were set.

Changing the index picture of a clip

You can change index pictures during clip previews.

- 1 Play a clip, and display the frame you want to use as the index picture.
- 2 Select [Set Index Picture] from the [Edit] menu, or click the Set Index Picture button.

The currently displayed frame becomes the clip’s index picture, and the Index Picture in the General tab of the clip properties section changes to show it.

Notes

- If you are previewing a clip that is stored on removable media, do not eject the media until the operation finishes.
- Do not power the computer off until the operation finishes.
- On XDCAM EX devices, a frame near the specified frame may be displayed as the index picture, instead of the specified frame itself.
- If you press the Set Index Picture button during play of the clip, the thumbnail view may show no change before the play is finished.

Creating still images

- 1 Play a clip in an Explorer window, and stop at the scene you want to use as the still image.
- 2 Do one of the following.
 - Press the Capture Still Image button.
 - Select [Capture Still Image...] from the [File] menu.

A dialog opens in which you can specify the file name and storage destination.

- 3 Specify the file name and storage destination and click the [OK] button.

A bitmap still image is created from the frame selected in step 2.

Note

It is not possible to create still images from a clip on XDCAM disk.

Searching for clips

You can search for a clip in either of the following ways, depending on whether you know where the clip is located.

Folder search: When you know where the clip is located, you can search a specified folder for clips with specified properties.

Keyword search: When you know only the fact that the clip is located on the computer on which this application is installed, you can perform a keyword search.

Note

Always observe the following precautions during a search.

- Do not delete the target folder.
- Do not eject the target media.

- 1 Activate an Explorer window and do one of the following.
 - Click the Find button.
 - Select [Find...] from the [Edit] menu.

The Find dialog opens.

- 2 Specify search criteria.

Specified Folder tab

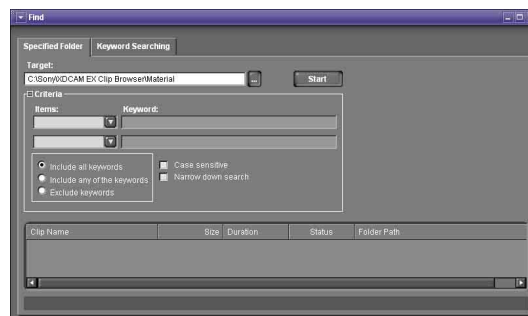

To search a different folder: Click the [...] button to open a browse dialog, select the target folder, and click the [OK] button.

To specify search criteria: Select at least one item from the [Items] list, and enter the matching condition in the text box for that item, or select the condition from the list.

To specify the type of search: Click “Include all keywords” (AND search), “Include any of the keywords” (OR search), or “Exclude keywords” (NOT search).

To specify search options: As required, check “Case sensitive” and “Narrow down search” (narrow down the search within the results of the previous search).

Note

When [Clip Name] is selected from the [Items] list, search is performed based on the [Clip Name] settings in the Display tab of the User Configuration dialog.

Keyword Searching tab

Notes

- On Windows XP, keyword search is available only when the latest version of Windows Desktop Search is installed.
- Keyword search uses Windows Desktop Search, so the search results depend on the functionality of Windows Desktop Search.
- Windows Desktop Search is an indexed search system. The index is updated at times when the computer is not being used for other tasks. Therefore, even if clips exist on the hard disk of the computer, they will not be found if they have not yet been indexed.
- Before performing a keyword search, register folders that contain clips in the Windows Desktop Search Options dialog, so that Windows Desktop Search will index the clips.

Refer to the Windows help for more information about Windows Desktop Search operations.

- The drives of XDCAM HD devices are not searched.

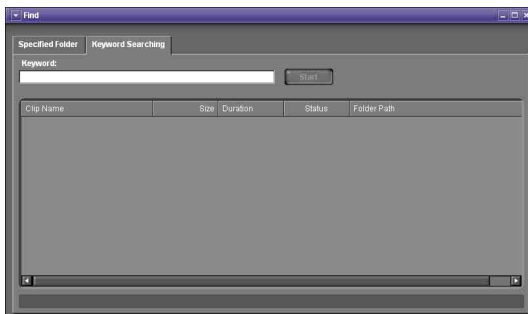

To specify the keywords to find: Enter the keywords to find in the Keywords box. You can enter multiple keywords. An AND search is performed (partial match). Uppercase and lowercase are not distinguished.

3 Click the Start button.

A list of search results appears in the Find dialog, containing clips that match the conditions specified in step 2.

To hide the search criteria in the Specified Folder tab

Click the “-” button.

Click the “+” button when conditions are hidden to show them again.

To sort the search results

Click the header of the column that you want to use as the sort key.

With each click, the list is sorted in ascending or descending order.

To display the search results in an Explorer window

Select one of the search results and do one of the following.

- Select [Go to Explorer] from the [Find] menu.
- Right click the result and select [Go to Explorer] from the context menu.

To play the search results

Select one of the search results and do one of the following.

- Select [Play] from the [Find] menu.
- Right click the result and select [Play] from the context menu.

Folder and Media Operations

Folder and media precautions

Always observe the following precautions during processing of folder and media operations.

- Do not power off the computer or media drive before the operation completes.
- Do not eject the media before the operation completes.

Folders for XDCAM EX clips

XDCAM EX clips are stored together with a BPAV folder (*see page 32*). (This folder does not appear in the Explorer window, but it can be seen in Windows Explorer.)

Whenever you copy or move clips with this application, the BPAV folder is copied or moved along with the clips. You cannot work with clips separately from the BPAV folder.

Note

Simultaneous access to files may not be possible when you attempt to access the same folder at the same time from several computers over a network connection.

Folders for MXF clips

A folder for managing MXF clips must have three subfolders: Clip, Edit, and Sub (*see page 33*). Clips cannot be saved in the Clip subfolder unless they match the clips existing in that subfolder in terms of the following characteristics.

- Frame rate (NTSC/PAL/24p)
- Codec (MPEG IMX/DVCAM/HD4:2:0/HD4:2:2)
- Resolution width (coincidence of resolution height not required).
- Bit rate when the codec is MPEG IMX

These conditions are determined by the format of the clip first saved in the Clip subfolder. When copying MXF clips, it is necessary to check the source clips and the clips existing in the copy destination folder to be sure that these conditions are satisfied.

Creating folders

- 1 In the Tree View pane of an Explorer window, select the media or folder where you want to create the folder.

- 2 Do one of the following.

- Click the New Folder button.
- From the [File] menu, select [Folder] and then select [New Folder].
- Right click the media or folder and select [New Folder] from the context menu.

A new folder is created in the media or folder selected in step 1.

Reasons why folder creation may fail

Folder creation operations may fail for the following reasons. In these cases, an error message appears and the folder is not created.

- You do not have write privileges for the selected media or folder.
- The selected media or folder is write protected.

Notes

- Folders cannot be created when writing is not allowed by the computer file system.
- New folders are created as normal folders. But when even one clip is copied or moved to the new folder, the folder is formatted as an XDCAM EX or XDCAM HD work folder. (The required subfolders and metadata files are created automatically.)

To rename a folder

- 1 Select a folder and do one of the following.

- From the [File] menu, select [Folder] and then select [Rename].
- Right click the folder and select [Rename] from the context menu.

The folder name is selected, so that now you can edit the name.

- 2 Enter a new name, and then press the Enter key or click somewhere outside the folder name.

Notes

- The name “BPAV” is reserved and cannot be specified.
- Characters forbidden by the operating system cannot be used in folder names.
- A folder name comprised of 200 or more characters may not be recognized.

To back up folders

- 1 In the Tree View pane of an Explorer window, select the folder that you want to back up.

2 Do one of the following.

- Select [Show in Windows Explorer...] from the [File] menu.
- Right click the folder and select [Show in Windows Explorer...] from the context menu.

Windows Explorer starts.

3 Perform your backup operations in Windows Explorer by copying the folder to other media or to another folder.

When a folder is too large to save to your backup media or folder

You can split the folder into smaller folders, and save them on separate discs. Split folders can later be combined to restore the original large folder.

See “Splitting folders” (page 30) and “Combining folders” (page 31) for more information.

Deleting folders

1 In the Tree View pane of an Explorer window, select the folder to delete.

2 Do one of the following.

- Press the Delete key.
- Click the Delete button.
- Select [Delete] from the [Edit] menu.
- Right click the folder and select [Delete] from the context menu.

A message appears asking if you want to execute the deletion.



3 Click the [Yes] button to execute the deletion, or the [No] button to cancel it.

Reasons why a folder deletion may fail

Folder deletion operations may fail for the following reasons. In these cases, an error message appears and folder is not deleted.

- You do not have delete/write privileges for the selected folder.
- The selected folder is write protected.
- Clips or other folders exist beneath the selected folder.¹⁾

Notes

- Be careful when deleting folders, because all data in the folder is deleted.
- Deletions cannot be undone after they finish.

1) The following examples show two situations in which a folder (Work1) cannot be deleted.

When there is a file that is not managed by XDCAM EX devices

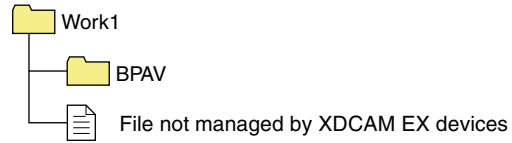

When there is another folder (Work2)

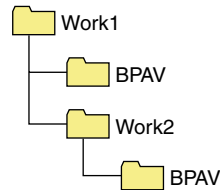

Normally, files which are not managed by XDCAM EX devices and folders such as Work2 must be deleted before the folder Work1 can be deleted. However, if you use Windows Explorer to create a folder or file in Work1 while this application is running, then Work1 may be deleted even while the folder or file still exists.

Splitting folders

You can split large folders into smaller folders. This allows you to back up all of the clips in a large folder to media that is not large enough to save the entire folder without splitting.

For example, you can split an 8 GB folder into two 4 GB folders in order to save them on 4 GB DVD-R media. Note that individual files in the large folder are not split.

Note

You cannot operate clips in other than XDCAM EX format (for example, XDCAM HD clips). You can operate XDCAM EX clips only.

1 In the Tree View pane of an Explorer window, select the folder to split.

2 Do one of the following.

- Click the Split Folder button.
- Select [Split Folder...] from the [Clip] menu.
- Right click the folder and select [Split Folder...] from the context menu.

The Split Folder dialog opens.



Note

The individual files in split folders are not split. Clips are assigned to the split folders in such a way that the split folders have the specified size. This means that it is not possible to specify a split folder size smaller than the largest file in the original folder. It is also not possible to specify a split folder size smaller than 4 GB.

- 3 Select the type of media from the [Media] list box.

The size of the folder after splitting, as determined by the selected media type, appears in the edit box beneath the list box.

If you select “Arbitrary Size”, enter the size (an integer from 4 to 100) in the edit box.

- 4 Click the [Start] button.

The folder is split into the minimum number of folders that will produce the specified folder size, and clips are assigned to the smaller folders. The folders produced as a result of the split have the same name as the original folder, followed by serial numbers.

Notes

- Once it starts, a split operation cannot be canceled before it finishes.
- Split clips may be assigned to different folders. If you would prefer that split clips be assigned to other folders, you can move them manually after the folder split.

Combining folders

You can combine specified folders into another folder. This allows you to restore the original folder from split folders.

Notes

- You cannot operate clips in other than XDCAM EX format (for example, XDCAM HD clips). You can operate XDCAM EX clips only.

- To become the target of combination, folders must reside on the same directory level and be under the management of this application (*see page 32*).

- 1 In the Tree View pane of an Explorer window, select the destination folder, into which the other folders will be combined.

- 2 Do one of the following.

- Select [Combine...] from the [Clip] menu.
- Right click the folder and select [Combine Folders...] from the context menu.

The Combine Folders dialog opens.

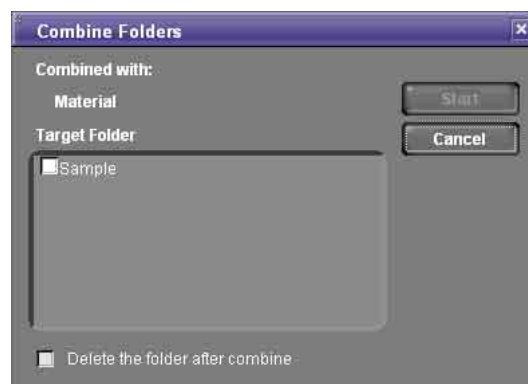

- 3 Check the check boxes of the folders that you want to combine into the folder selected in step 1. Check the [Delete folders after combine] check box if you want to delete the combined folders after the combine.

Note

The combined folders are not deleted when:

- They contain other folders.
- You do not have delete/write privileges to the original folders.
- The folders are write protected.

- 4 Click the [Start] button.

The folders selected in step 3 are combined into the destination folder specified in step 1. The clips in all of the folders are gathered into the destination folder. If any of the clips are split clips, they are automatically grouped, allowing them to be handled as a single clip.

Reasons why a folder combine operation may fail

Folder combine operations may fail for the following reasons. In these cases, an error message appears and the combine is not executed.

- There is not enough free capacity in the combine destination folder.
- You do not have write privileges to the source or destination folders.
- The source or destination folders are write protected.

- Multiple instances of the same clip exist.

Checking/editing disc metadata

You can check and edit the disc metadata (DISCMETA.XML) (see page 33) saved on XDCAM drives or in folders with MXF attributes.

- 1 In the Tree View pane of an Explorer window, select an XDCAM drive or a folder with MXF attributes.
- 2 Do one of the following.
 - Select [Edit Disc Metadata...] from the [Edit] menu.
 - Right click the XDCAM drive or folder with MXF attributes and select [Edit Disc Metadata...] from the context menu.

The Edit Disc Metadata dialog opens.

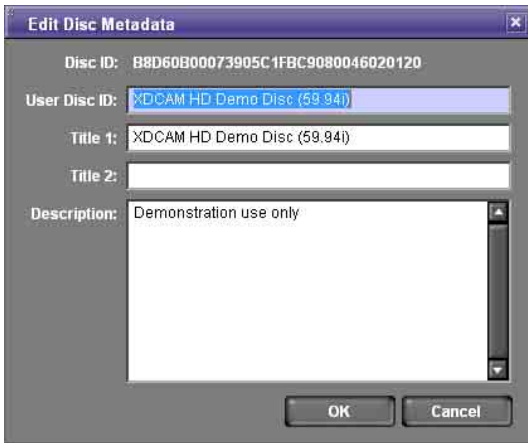

- 3 Edit the following items as required.
 - User Disc ID (up to 127 bytes)
 - Title 1 (up to 63 bytes)
 - Title 2 (up to 127 bytes)
 - Description (up to 2047 bytes)

- 4 Click the [OK] button.

Appendix

How XDCAM EX clip data are configured

Recording format

This application supports the format specified for XDCAM EX devices. This format has the following specifications.

- Folder names and the folder configuration are as shown in the following figure.
- Files contain link information pertaining to links between files and folders.

Notes

- Do not use tools that do not support the XDCAM EX format to edit, delete, move, or rename the files and folders used by this application. Unless the format specifications are observed, files can become unreadable by XDCAM EX devices and by this application.
- It may not be possible for XDCAM EX devices to play clips that this application has created on, copied to, or moved to media other than SxS PRO memory cards.

Recording folders

The configuration of video and metadata folders is as shown in the following figure.

In the XDCAM EX format, the data beneath the BPAV folder is handled as a single set of data.

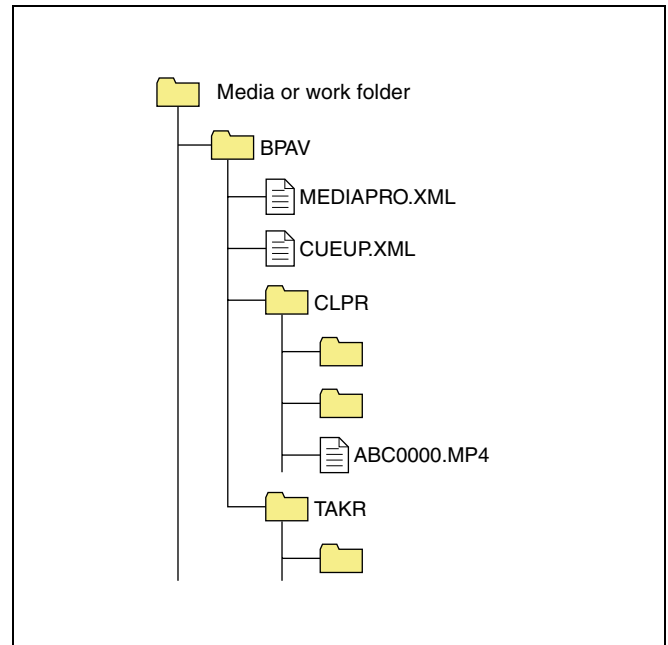

- One BPAV folder exists when a work folder is opened in Windows Explorer.
- To copy and backup your data, select the folders beneath the BPAV folder.
- When a work folder is selected in a Tree View pane of Explorer window, a list of clips registered in the BPAV folder appears in the corresponding List View pane. AV data is saved in the folders beneath the CLPR folder.
- On the media used by XDCAM EX devices, the BPAV folder is created beneath the root folder of the media.
- When a work folder is selected in a Tree View pane of Explorer window and the CLPR folder in the work folder has some MP4 files, new folders are created beneath the CLPR folder, and the MP4 files are moved to those folders (the effect is the same as importing the MP4 files).¹⁾
- When MP4 files are imported to a work folder, new folders are created beneath the CLPR folder, and the imported clips are moved to those folders. Folder names are assigned automatically.
- On SxS memory cards and the PHU-60 Professional Hard Disk Unit, up to 600 clips can be registered in one recording folder.

1) This process does not work in the UserData folders on XDCAM drives.

Note

Folder and file names are linked to metadata files. Do not change them.

How MXF clip data are configured

Recording format

This application supports the format specified for XDCAM HD devices. This format has the following specifications.

- Folder names and the folder configuration are as shown in the following figure.
- Files contain link information pertaining to links between files and folders.

Notes

- Do not use tools that do not support the XDCAM HD format to edit, delete, move, or rename the files and folders used by this application. Unless the format specifications are observed, files can become unreadable by XDCAM HD devices and by this application.
- It may not be possible for XDCAM HD devices to play clips that this application has created on, copied to, or moved to media other than Professional Discs (XDCAM drives).

Recording folders

The configuration of video and metadata folders is as shown in the following figure.

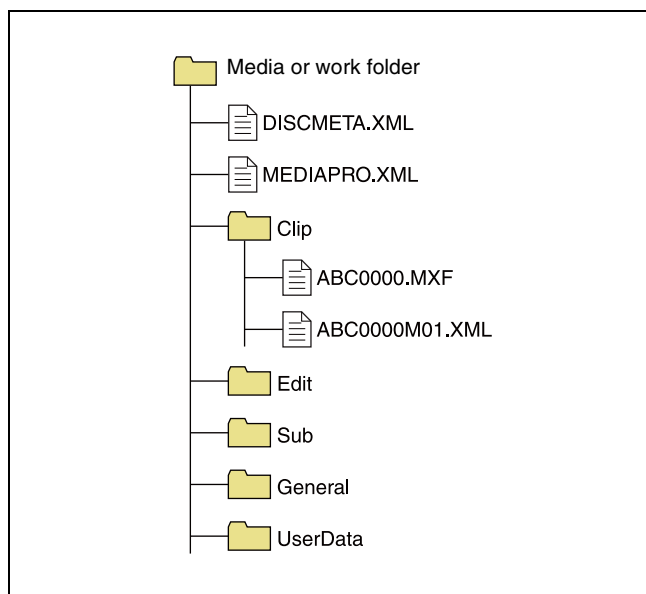

- This application recognizes a folder containing the three subfolders -- Clip, Edit, and Sub -- as a folder with MXF attributes, and browses the Clip folder.
- If XDCAM Drive in the General tab of the User Configuration dialog is set to "UserData," this application browses the UserData folder instead of the Clip folder (*see page 34*).
- If file format conversion is executed by copying files to a normal folder (*see page 19*), DISCMETA.XML and MEDIAPRO.XML files, and Clip, Edit, Sub, and General folders are automatically created, and then the format-converted files are copied to the Clip folder. (For example, when the file named ABC0000.MP4 is copied to a work folder, the format is converted to MXF and the files named ABC0000.MXF and ABC0000M01.XML are automatically created and saved in the Clip folder.)

Notes

- Folder and file names are linked to metadata files. Do not change them.
- Even if you configure clip data like MXF clip data in an EX folder using Windows Explorer or other file management tools, this application gives priority to the XDCAM EX format so that you cannot operate MXF clips.

For details about the data configuration for MXF clips, refer to the Operating Instructions or Operation Manual supplied with the XDCAM HD device.

User settings

The User Configuration dialog allows you to select application options and processing modes.

To open the User Configuration dialog, select [Options...] from the [Tool] menu.

General tab

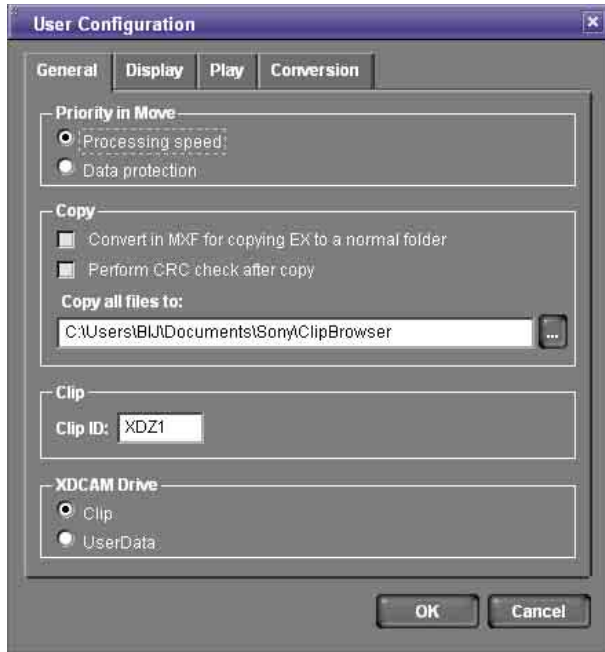

Priority in Move: Specifies whether to give priority to operating speed or data protection when moving clips (*see page 20*).

- Processing speed: Normal move processing, without creating a duplicate of the clip
- Data protection: Creation of a duplicate before deletion of the original clip

Convert in MXF for copying EX to a normal folder:

When EX format files are copied to a normal folder (without EX or MXF attributes) with this check box checked, the copies are automatically converted to the MXF format.

Perform CRC check after copy: When this check box is checked, the application performs a CRC (cyclic redundancy check) error check after copying a file, and displays a message if a copy error is detected.

Copy all files to: Specifies the destination folder for the Copy All command that copies all clips in a folder or on a media disc or memory card (*see page 20*). Enter a path beginning with a drive name in the edit box. Or click the [...] button to open a browse dialog, select a folder, and click the [OK] button.

Clip ID: Specifies up to four characters added to the start of imported clip names, and to the name of the folder where the imported clips are saved (*see page 22*).

XDCAM Drive: Specifies the folder on an XDCAM drive that this application will use.

- Clip: Uses the Clip folder. In this mode, only MXF clips on the XDCAM drive can be operated (XDCAM EX clips cannot be operated). An “XDCAM Drive (normal)” icon is displayed in the Tree View pane (*see page 13*).
- UserData: Uses the UserData folder. In this mode, only XDCAM EX clips on the XDCAM drive can be operated (MXF clips cannot be operated). This mode is for backup of XDCAM EX clips. An “XDCAM drive (UserData)” icon is displayed in the Tree View pane (*see page 13*).

For details about the data management structure for the XDCAM drive available in this application, *see page 33*.

Display tab

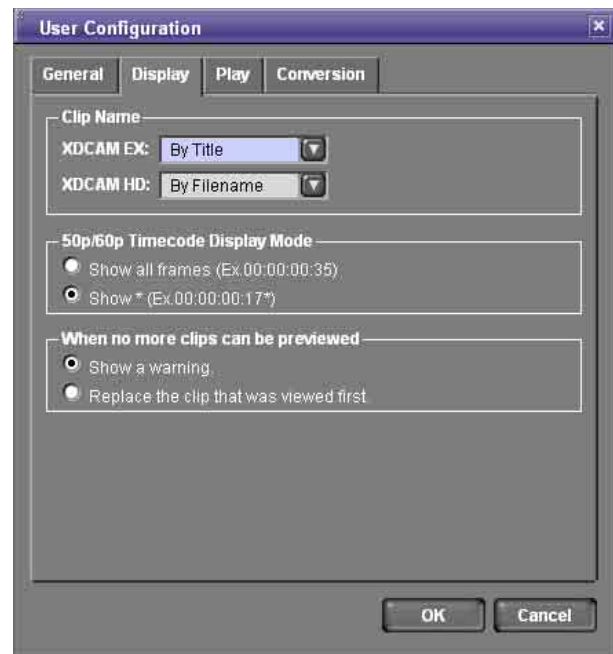

Clip Name: Specifies what to display as the clip name for each clip type.

- By Title: Displays the title as the clip name.
- By Filename: Displays the file name as the clip name.

Note

Even if “By Title” is selected, the file name is displayed for a clip with no title assigned.

50p/60p Timecode Display Mode: Specifies the timecode display format when the frame frequency of the playback clip is 50p or 60p.

- Show all frames: The frame number increases on each frame. (Example of frame number display for 60p clips: 00 → 01 → 02 → ... → 58 → 59 → 00 → ...)

- Show *: The frame number increases on every second frame. An asterisk (*) is added to indicate the second frame in each frame number pair. (This is the display format used by Sony VTRs.) (Example of frame number display for 60p clips: 00 → 00* → 01 → ... → 29 → 29* → 00 → ...)

When no more clips can be previewed: Specifies what to do when the number of clips in Preview windows (simultaneously open windows or tabs) exceeds the number that can be previewed at one time.

- Show a warning.
- Replace the clip that was viewed first.

Play tab



Resolution: Specifies the preview playback resolution.

- Auto: Decodes the playback video at a resolution which is automatically adjusted to match the screen size.
- Normal: Decodes the playback video at the original resolution of the clip, regardless of the screen size.
- 1/2, 1/4: Decodes the playback video at half or quarter resolution. The image quality is lower, but response is better because of the lower demands placed on the decoder.

MXF Play mode: Specifies the playback mode of MXF clips.

- MPEG HD: Plays the clips at high resolution (plays MXF clips as is).
- Proxy: Plays the clips at low resolution (plays the proxy AV data).

For notes on the playback mode of MXF clips, see page 26.

Conversion tab

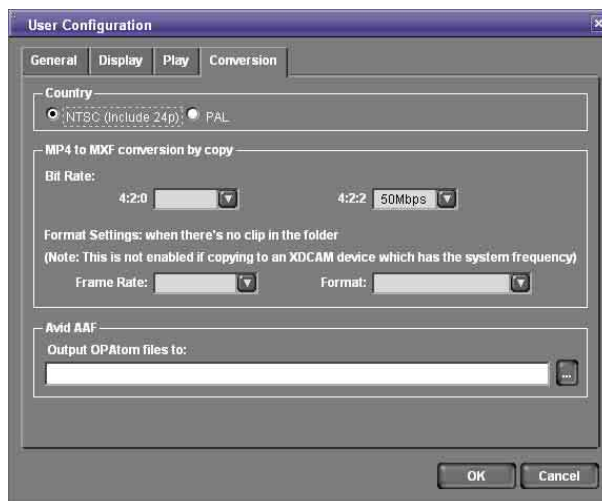

Country: Specifies the video system adopted in the region where the application is used.

- NTSC (Include 24p)
- PAL

MP4 to MXF conversion by copy: Specifies the recording format to be used at the time of file format conversion from MP4 to MXF by copy operation.

- Bit Rate
 - Specifies the bit rate of the converted file for each color format when file format conversion is performed by copy operation.
 - 4:2:0: Selects 18Mbps, 25Mbps, or 35Mbps.
 - 4:2:2: Fixed to 50Mbps.
- Format Settings: when there's no clip in the folder
 - Specifies the recording format (frame rate and format) to be used when no clip exists at the copy destination during file format conversion by copy operation. The following combinations of the values can be set.

| Country | Frame Rate | Format |
|--------------------|----------------------|----------------------|
| NTSC (Include 24p) | 60i/60p/30p | 4:2:0 18Mbps (x1080) |
| | | 4:2:0 25Mbps (x720) |
| | | 4:2:0 25Mbps (x1080) |
| | | 4:2:0 35Mbps (x720) |
| | | 4:2:0 35Mbps (x1080) |
| | | 4:2:2 50Mbps |
| | 24p | 4:2:0 18Mbps (x1080) |
| | 4:2:0 25Mbps (x1080) | |
| | 4:2:0 35Mbps (x1080) | |
| PAL | 50i/50p/25p | 4:2:0 18Mbps (x1080) |
| | | 4:2:0 25Mbps (x720) |
| | | 4:2:0 25Mbps (x1080) |
| | | 4:2:0 35Mbps (x720) |
| | | 4:2:0 35Mbps (x1080) |
| | | 4:2:2 50Mbps |

For details about the file format conversion by copy operation, see page 19.

Output OPAtom files to: Specifies the output folder for OPAtom files for the [Avid AAF] subcommand of the Export command (see next item “To set the media folder in Avid editing systems”). Enter a path beginning with a drive name in the edit box. Or click the [...] button to open a browse dialog where you can select a folder, and then click the [OK] button.

To set the media folder in Avid editing systems
For Avid Media Composer (V2.5.3 or later), proceed as follows.

1 Select [Media Creation] from the [Settings] menu.

The Media Creation dialog opens.

2 Specify the Video Drive/Audio Drive (media storage drive) in the Import tab.

- Windows XP: Any hard disk drive
- Windows Vista: Any hard disk drive except the drive where Windows Vista is installed

3 Import an MXF file into Avid Media Composer.

An “Avid Media Files\MXF\1” folder is created in the drive specified in step 2.

Specify this folder in the [Output OPAtom files to] box.

Menu list

This section lists the menus of this application as they appear when application windows are activated.

In the Keyboard shortcut field, the notation “Ctrl + N” means that the N key is pressed while holding down the Ctrl key.

Main window is only open window

| Menu | Command | Subcommand | Keyboard shortcut | Function | Reference page |
|--------|------------------------|----------------------|-------------------|---|----------------|
| File | Exit | – | Alt + F4 | Exits this application. | Page 9 |
| View | Message Options | Reset to the default | – | Subsequently displays the message box which was set to be hidden by the setting of the [Do not show this message in the future.] check box. | – |
| Tool | Options... | – | – | Opens the User Configuration dialog. | Page 34 |
| Window | New Explorer Window | – | – | Opens a new Explorer window. | Page 11 |
| | New Preview Window | – | – | Opens a new Preview window. | |
| Help | About Version... | – | – | Displays the version of this application. | – |
| | MainConcept Version... | – | – | Displays the version of the MainConcept plug-in software. | – |

Explorer window is active

| Menu | Command | Subcommand | Keyboard shortcut | Function | Reference page | |
|---------------------------|-----------------------------|--|---------------------------|---|--|---------|
| File | Folder | New Folder | Ctrl + N | Creates a new folder in the currently selected media or folder. | Page 29 | |
| | | Rename | Ctrl + R | Renames the selected folder. | Page 29 | |
| | Show in Windows Explorer... | – | – | Opens the selected folder in Windows Explorer, so that you can back up the folder contents. | Page 29 | |
| | Import... | – | – | Imports an MP4 file to the selected folder. | Page 22 | |
| | Export | | MXF for NLEs... | – | Converts the selected clip to MXF format, for use on non-linear editors. | Page 23 |
| | | | MXF for XDCAM HD... | – | Converts the selected clip to XDCAM HD format. | |
| | | | MXF for XDCAM HD422... | – | Converts the selected clip to XDCAM HD422 format. | |
| | | | MXF for XDCAM MPEG IMX... | – | Converts the selected clip to XDCAM MPEG IMX format. | |
| | | | MXF for XDCAM DVCAM... | – | Converts the selected clip to XDCAM DVCAM format. | |
| | | | Raw DV... | – | Converts the selected clip to RAW DV format. | |
| | | | AVI DV... | – | Converts the selected clip to AVI DV format. | |
| | | | Avid AAF... | – | Converts the selected clip to Avid AAF format. | |
| | | | Windows Media File... | – | Converts the selected clip to Windows Media file format. | |
| | | | Sony PSP (H.264/AVC)... | – | Converts the selected clip to a format for viewing on the PlayStation Portable (PSP) game console. | |
| Apple iPod (H.264/AVC)... | – | Converts the selected clip to a format for viewing on the Apple iPod. | | | | |
| Video hosting service... | – | Converts the selected clip to a format for uploading to video hosting service. | | | | |
| Exit | – | Alt + F4 | Exits this application. | Page 9 | | |
| Edit | Cut | – | Ctrl + X | Cuts the selected clip. | Page 20 | |
| | Copy | – | Ctrl + C | Copies the selected clip. | Page 18 | |
| | Paste | – | Ctrl + V | Pastes a clip that has been cut or copied. | Page 18 Page 20 | |
| | Delete | – | Delete | Deletes the selected clip or folder. | Page 21 Page 30 | |
| | Copy All | – | Ctrl + Shift + C | Copies all of the clips in the selected media or folder. | Page 20 | |
| | Select All | – | Ctrl + A | Selects all of the clips in the selected media or folder. | – | |
| | Find... | – | Ctrl + F | Opens the Find dialog. | Page 27 | |
| | Edit Disc Metadata... | – | – | Opens the Edit Disc Metadata dialog. | Page 32 | |

| Menu | Command | Subcommand | Keyboard shortcut | Function | Reference page | |
|----------------------|-------------------------------|---------------|--|---|--|---------|
| View | Command Bar | – | – | Shows or hides the tool buttons. | Page 12 | |
| | Folder Tree | – | – | Shows or hides the Tree View pane. | Page 12 | |
| | Disk Space | – | – | Shows or hides the disc capacity display. | Page 13 | |
| | Status Bar | – | – | Shows or hides the status information of the selected clip. | Page 13 | |
| | Thumbnails | – | – | Puts the List View pane into thumbnail view mode. | Page 13 | |
| | List | – | – | Puts the List View pane into list view mode. | | |
| | Details | – | – | Puts the List View pane into details view mode. | | |
| | Sort by | Clip Name | – | – | Sorts the clip list on the selected key, in ascending or descending order. | |
| | | Size | – | | | |
| | | Duration | – | | | |
| | | Status | – | | | |
| | | Creation date | – | | | |
| | | Last Update | – | | | |
| | | Rec Mode | – | | | |
| Media Spanning | | – | | | | |
| Save Sort Order | – | – | Saves the current sort order for the current folder. | – | | |
| Customize Columns... | – | – | – | Opens the Customize Columns dialog. | Page 15 | |
| Message Options | Reset to the default | – | – | Subsequently displays the message box which was set to be hidden by the setting of the [Do not show this message in the future.] check box. | – | |
| Up | – | – | Backspace | Moves up one level in the folder hierarchy. | – | |
| Refresh | – | – | F5 | Refreshes the information displayed in the active tab of the Explorer window. | – | |
| Clip | New clip using In/Out section | – | – | Creates a new clip from the section between In and Out points of the selected clip. | Page 22 | |
| | Split Folder... | – | – | Ctrl + W | Splits the selected folder into folders of the specified size. | Page 30 |
| | Combine Folders... | – | – | Ctrl + J | Combines the selected folder to another specified folder. | Page 31 |
| | Play | – | – | Space | Plays the selected clip. | Page 25 |
| Tool | Options... | – | – | – | Opens the User Configuration dialog. | Page 34 |

| Menu | Command | Subcommand | Keyboard shortcut | Function | Reference page |
|--------|---------------------------|------------|-------------------|---|----------------|
| Window | New Explorer Window | – | – | Opens a new Explorer window. | <i>Page 11</i> |
| | New Preview Window | – | – | Opens a new Preview window. | |
| | Close Window | – | Ctrl + F4 | Closes the active window. | – |
| | New Tab | – | – | Adds a new tab in the active window. | – |
| | Close Tab | – | – | Closes the active tab. | – |
| | Previous Tab | – | Ctrl + PageUp | Selects the previous tab. | <i>Page 11</i> |
| | Next Tab | – | Ctrl + PageDown | Selects the next tab. | |
| | Optimize Window Layout | – | – | Optimizes the positions of Explorer and Preview windows in the main window. | <i>Page 11</i> |
| | Cascade | – | – | Arranges the currently open windows in cascading order from the upper left. | – |
| | Tile Windows Vertically | – | – | Tiles the currently open windows vertically. | – |
| | Tile Windows Horizontally | – | – | Tiles the currently open windows horizontally. | – |
| Help | About Version... | – | – | Displays the version of this application. | – |
| | MainConcept Version... | – | – | Displays the version of the MainConcept plug-in software. | – |

Preview window is active

| Menu | Command | Subcommand | Keyboard shortcut | Function | Reference page |
|------|------------------------|------------|-------------------|--|----------------|
| File | Capture Still Image... | – | – | Creates a bitmap still picture from the frame at the current position. | <i>Page 27</i> |
| | Exit | – | Alt + F4 | Exits this application. | <i>Page 9</i> |

| Menu | Command | Subcommand | Keyboard shortcut | Function | Reference page |
|------|-----------------------|----------------------|-------------------|---|----------------|
| Edit | Cut | – | Ctrl + X | Cuts the selected text in the clip properties section of the General tab. | <i>Page 17</i> |
| | Copy | – | Ctrl + C | Copies the selected text in the clip properties section of the General tab. | |
| | Paste | – | Ctrl + V | Pastes text that was cut or copied in the clip properties section of the General tab. | |
| | Delete | – | Delete | Deletes the selected text in the clip properties section of the General tab. | |
| | Set Index Picture | – | P | Sets the frame at the current position as the index picture. | <i>Page 27</i> |
| | Mark In | – | I | Sets an In point at the current position. | <i>Page 22</i> |
| | Mark Out | – | O | Sets an Out point at the current position. | |
| | Clear Mark In | – | Shift + I | Clears the In point. | |
| | Clear Mark Out | – | Shift + O | Clears the Out point. | |
| | Clear Mark In/Out | – | Shift + X | Clears the In and Out points. | |
| | Add Essence Mark | – | E | Sets an essence mark at the current position (up to 126). | – |
| | Delete Essence Mark | – | Shift + E | Deletes the essence mark at the current position. | – |
| | Edit Essence Marks... | – | – | Opens the Edit Essence Marks dialog. | <i>Page 26</i> |
| View | Full Screen | – | Alt + Enter | Puts the Viewer into Full Screen mode. | <i>Page 16</i> |
| | Message Options | Reset to the default | – | Subsequently displays the message box which was set to be hidden by the setting of the [Do not show this message in the future.] check box. | – |

| Menu | Command | Subcommand | Keyboard shortcut | Function | Reference page |
|--------|---------------------------|------------|-------------------|---|----------------|
| Play | Play | – | L or space | Plays the selected clip. | <i>Page 25</i> |
| | Stop | – | K or space | Stops clip play. | |
| | Play Reverse | – | J | Plays the selected clip in the reverse direction. | |
| | Play In to Out | – | Shift + space | Plays the range from the In point to the Out point of the selected clip. | |
| | –1 Frame | – | ← | Steps one frame back. | |
| | +1 Frame | – | → | Steps one frame forward. | |
| | Jump to Start | – | Home | Jumps to the clip start point (first frame). | |
| | Jump to End | – | End | Jumps to the clip end point (last frame). | |
| | Jump to In Point | – | ↑ | Jumps to the In point. | |
| | Jump to Out Point | – | ↓ | Jumps to the Out point | |
| | Previous Essence Mark | – | Shift + ← | Jumps to the previous essence mark. | |
| | Next Essence Mark | – | Shift + → | Jumps to the next essence mark. | |
| | Set Audio Channels... | – | – | Opens the Set Audio Channels dialog. | <i>Page 26</i> |
| Tool | Options... | – | – | Opens the User Configuration dialog. | <i>Page 34</i> |
| Window | New Explorer Window | – | – | Opens a new Explorer window. | <i>Page 11</i> |
| | New Preview Window | – | – | Opens a new Preview window. | |
| | Close Window | – | Ctrl + F4 | Closes the active window. | – |
| | Close Tab | – | – | Closes the active tab. | – |
| | Previous Tab | – | Ctrl + PageUp | Selects the previous tab. | <i>Page 11</i> |
| | Next Tab | – | Ctrl + PageDown | Selects the next tab. | |
| | Optimize Window Layout | – | – | Optimizes the positions of Explorer and Preview windows in the main window. | <i>Page 11</i> |
| | Cascade | – | – | Arranges the currently open windows in cascading order from the upper left. | – |
| | Tile Windows Vertically | – | – | Tiles the currently open windows vertically. | – |
| | Tile Windows Horizontally | – | – | Tiles the currently open windows horizontally. | – |
| Help | About Version... | – | – | Displays the version of this application. | – |
| | MainConcept Version... | – | – | Displays the version of the MainConcept plug-in software. | – |

Find window is active

| Menu | Command | Subcommand | Keyboard shortcut | Function | Reference page |
|------|---------|------------|-------------------|-------------------------|----------------|
| File | Exit | – | Alt + F4 | Exits this application. | <i>Page 9</i> |

| Menu | Command | Subcommand | Keyboard shortcut | Function | Reference page |
|-----------------|---------------------------|----------------|-------------------|---|----------------|
| View | Search Criteria | – | – | Shows or hides the search criteria. | <i>Page 27</i> |
| | Sort by | Clip Name | – | Sorts the results list on the selected key, in ascending or descending order. | |
| | | Size | – | | |
| | | Duration | – | | |
| | | Status | – | | |
| | | Creation date | – | | |
| | | Last Update | – | | |
| | | Rec Mode | – | | |
| | | Media Spanning | – | | |
| | Folder Path | – | – | – | |
| Message Options | Reset to the default | – | – | – | – |
| Find | Start | – | – | Starts the search. | <i>Page 27</i> |
| | Stop | – | – | Stops the search. | |
| | Go to Explorer | – | – | Opens the selected clip in an Explorer window. | |
| | Play | – | – | Plays the selected clip. | |
| Tool | Options... | – | – | Opens the User Configuration dialog. | <i>Page 34</i> |
| Window | New Explorer Window | – | – | Opens a new Explorer window. | <i>Page 11</i> |
| | New Preview Window | – | – | Opens a new Preview window. | |
| | Close Window | – | Ctrl + F4 | Closes the active window. | – |
| | Cascade | – | – | Arranges the currently open windows in cascading order from the upper left. | – |
| | Tile Windows Vertically | – | – | Tiles the currently open windows vertically. | – |
| | Tile Windows Horizontally | – | – | Tiles the currently open windows horizontally. | – |
| Help | About Version... | – | – | Displays the version of this application. | – |
| | MainConcept Version... | – | – | Displays the version of the MainConcept plug-in software. | – |

Error and warning message list

| Messages | What to do |
|--|--|
| Failed to initialize OLE. Please confirm whether the OLE library version is correct. | There may be a problem with the installation of this application. Try installing it again. |
| Failed to read libraries for Export. | |

| Messages | What to do |
|--|---|
| The folder contains some incomplete clips. Please copy all files in the [BPAV] folder under the selected folder to an SxS card and execute salvage operation on the recording equipment. | Data on the media is incomplete, probably because the XDCAM EX device was powered off during recording, or because the media was ejected prematurely. Return the media to the XDCAM EX device and salvage it immediately. The data may become unrecoverable if you continue to operate without salvaging it. |
| Incomplete clip exists. Please execute salvage operation on the recording equipment. | |
| Reason: The clip database is incorrect. | The XDCAM EX format may be corrupt. Try to salvage the material, for example by importing an MP4 file to another folder. |
| The clip cannot be displayed in Explorer. | Check the properties of the selected clip. It cannot be imported or displayed in the list because the format is not compatible with the XDCAM EX format. |
| Failed to save sort order. | Try restarting this application, or restarting the computer. If the problem persists, install the application again. |
| The clip database is incorrect, so it cannot be copied. | The XDCAM EX format may be corrupt. Try to salvage the material, for example by importing an MP4 file to another folder. |
| The clip database is incorrect, so it cannot be moved. | |
| Failed to update properties. | |
| A file exceeding 4 GB needs to be split, so the file cannot be copied. | Files larger than 4 GB cannot be managed on media like the SxS memory cards used by XDCAM EX devices. Use editing software or some other tool to split the file into files smaller than 4 GB and then try again. |
| A file exceeding 4 GB needs to be split, so the file cannot be moved. | |
| Failed to create a clip. | The operation was cancelled for one of the following reasons. <ul style="list-style-type: none"> You do not have delete and write privileges to the selected media or folder, or these operations are inhibited. The data is in an incompatible format, or it is corrupt. Check the properties of the media or folder. |
| Reason: Unmatched frame rate. | The selected clip cannot be copied due to difference in frame rate between that clip and clips existing in the copy destination folder. Check the frame rate (NTSC/24p/PAL) of the clip you want to copy and then perform copy by selecting a destination folder in which all the existing clips are of the same frame rate as the selected clip. |
| Reason: The video format is different. | The selected clip cannot be copied due to difference in resolution between that clip and clips existing in the copy destination folder. Check the resolution of the clip that you want to copy and then perform copy by selecting a destination folder in which all the existing clips are of the same resolution as the selected clip. |
| Reason: Default format hasn't been set. Please check Conversion tab in User Configuration. | Set the frame rate and bit rate in the [Rates to apply when rec format is unknown] section of the Conversion tab in the User Configuration dialog. |
| Reason: Bit Rate hasn't been set. Please check Conversion tab in User Configuration. | Make settings in the [MP4 to MXF conversion bit rate] section of the Conversion tab in the User Configuration dialog. |
| Reason: Failed to convert. | Check the recording format of the clip that you want to copy and that of the clips existing in the copy destination folder. File conversion may be disabled depending on the recording format of the original clip and the clips in the copy destination folder. |
| Reason: The clip is less than 2 seconds, so it cannot be written. | XDCAM devices do not support writing of clips shorter than two seconds. |
| It cannot be copied because a Clip less than 2 seconds is included. | |
| UserData folder cannot be specified as the destination to copy MXF files. Please change the Copy All destination in User Configuration. | Change the setting in [Copy all files to:] of the General tab in the User Configuration dialog. |
| Failed to import the clip. | Check the properties of the clip. You may not have access privileges to the clip, or the clip may be an MP4 file that is not compatible with the XDCAM EX format. |
| UserData folder cannot be specified as the output destination. | Change the output destination. |

| Messages | What to do |
|--|--|
| UserData folder cannot be specified as the destination to output OPAtom files. Please change the OPAtom file output destination in User Configuration. | Change the setting in [Output OPAtom files to:] of the Conversion tab in the User Configuration dialog. |
| The name is already used. Please specify other name. | Specify other name or change the output destination. |
| Error occurred during the export. Please refer to the details from the context on each clip. | Open the export dialog to check the report which is displayed when [Error detail] is selected from the context menu of the clip with the error. |
| Reason: An error occurred during conversion. | The conversion failed for one of the following reasons. <ul style="list-style-type: none"> You do not have delete and write privileges to the output folder, or these operations are inhibited. The selected clip is in an unsupported format, or the material data is corrupt. Check the properties of the folder and clip. |
| Reason: Unsupported XDCAM. | The selected XDCAM drive is not supported. |
| Reason: Unsupported codec. | The codec of the selected clip on the XDCAM drive is not supported. |
| Failed to create a folder. | Check the properties of the selected media or folder. You may not have delete and write privileges to the media or folder, or these operations may be inhibited. |
| You cannot use [XXX] as a folder name. Please specify another name. | Specify a name other than "BPAV". |
| It contains a string reserved by the system, so it cannot be set. | The name contains characters reserved by the operating system. Enter a name that does not contain these characters. |
| Reason: The clip file name has already been reserved. | Change the file name or copy destination. |
| Failed to change the folder name. | Check the properties of the selected folder. You may not have delete and write privileges to the folder, or these operations may be inhibited. |
| Failed to delete the folder. | |
| Failed to split the folder. | |
| Failed to combine the folders. | Check the properties of the combine source or destination folder. You may not have delete and write privileges to these folders, or these operations may be inhibited. |
| [XXX] contains a work folder, so it cannot be deleted. | The selected media or folder contains one or more folders that are not under the management of this application. Delete or move these folders and then try again. |
| Reason: [XXX] has a sub folder. | |
| The folder [XXX] cannot be split. Reason: The folder contains a file exceeding the specified split unit of [XXX GB]. Clip name: | The folder cannot be split into folders of the specified size because at least one file larger than that size exists. Specify a split size that is larger than the size of the largest file. |
| Failed to save disc metadata. | Check the properties of the selected XDCAM drive and the state of the write protect tab on the disc. You may not have delete and write privileges for the selected XDCAM drive, or these operations may be inhibited. |

How to obtain the plug-in software

The optional MainConcept plug-in software can be purchased and downloaded from the following website.
<http://www.mainconcept.com/plugin4clipbrowser>

Licenses

MPEG-4 Visual Patent Portfolio License

THIS PRODUCT IS LICENSED UNDER THE MPEG-4 VISUAL PATENT PORTFOLIO LICENSE FOR THE

PERSONAL AND NONCOMMERCIAL USE OF A CONSUMER FOR
(i) ENCODING VIDEO IN COMPLIANCE WITH THE MPEG-4 VISUAL STANDARD ("MPEG-4 VIDEO") AND/OR
(ii) DECODING MPEG-4 VIDEO THAT WAS ENCODED BY A CONSUMER ENGAGED IN A PERSONAL AND NON-COMMERCIAL ACTIVITY AND/OR WAS OBTAINED FROM A VIDEO PROVIDER LICENSED BY MPEG LA TO PROVIDE MPEG-4 VIDEO.

NO LICENSE IS GRANTED OR SHALL BE IMPLIED FOR ANY OTHER USE.

ADDITIONAL INFORMATION INCLUDING THAT RELATING TO PROMOTIONAL, INTERNAL AND COMMERCIAL USES AND LICENSING MAY BE OBTAINED FROM MPEG LA, LLC. SEE [HTTP://WWW.MPEGLA.COM](http://WWW.MPEGLA.COM)

MPEG LA is offering licenses for (i) manufacturing/sales of any storage media storing MPEG-4 Visual video information (ii) distribution/broadcasting of MPEG-4 Visual video information in any manner (such as online video distribution service, internet broadcasting, TV broadcasting). Other usage of this product may be required to obtain license from MPEG LA. Please contact MPEG LA for any further information. MPEG LA, L.L.C., 250 STEELE STREET, SUITE 300, DENVER, COLORADO 80206, <http://www.mpegla.com>

(ii)DECODE VC-1 VIDEO THAT WAS ENCODED BY A CONSUMER ENGAGED IN A PERSONAL AND NON-COMMERCIAL ACTIVITY AND/OR WAS OBTAINED FROM A VIDEO PROVIDER LICENSED TO PROVIDE VC-1 VIDEO. NO LICENSE IS GRANTED OR SHALL BE IMPLIED FOR ANY OTHER USE. ADDITIONAL INFORMATION MAY BE OBTAINED FROM MPEG LA, L.L.C. SEE [HTTP://WWW.MPEGLA.COM](http://WWW.MPEGLA.COM)

MPEG-2 Video Patent Portfolio License

ANY USE OF THIS PRODUCT OTHER THAN CONSUMER PERSONAL USE IN ANY MANNER THAT COMPLIES WITH THE MPEG-2 STANDARD FOR ENCODING VIDEO INFORMATION FOR PACKAGED MEDIA IS EXPRESSLY PROHIBITED WITHOUT A LICENSE UNDER APPLICABLE PATENTS IN THE MPEG-2 PATENT PORTFOLIO, WHICH LICENSE IS AVAILABLE FROM MPEG LA, L.L.C., 250 STEELE STREET, SUITE 300, DENVER, COLORADO 80206.

AVC Patent Portfolio License

THIS PRODUCT IS LICENSED UNDER THE AVC PATENT PORTFOLIO LICENSE FOR THE PERSONAL AND NON-COMMERCIAL USE OF A CONSUMER TO

(i) ENCODE VIDEO IN COMPLIANCE WITH THE AVC STANDARD (“AVC VIDEO”)

AND/OR

(ii)DECODE AVC VIDEO THAT WAS ENCODED BY A CONSUMER ENGAGED IN A PERSONAL AND NON-COMMERCIAL ACTIVITY AND/OR WAS OBTAINED FROM A VIDEO PROVIDER LICENSED TO PROVIDE AVC VIDEO.

NO LICENSE IS GRANTED OR SHALL BE IMPLIED FOR ANY OTHER USE. ADDITIONAL INFORMATION MAY BE OBTAINED FROM MPEG LA, L.L.C. SEE [HTTP://WWW.MPEGLA.COM](http://WWW.MPEGLA.COM)

VC-1 Patent Portfolio License

THIS PRODUCT IS LICENSED UNDER THE VC-1 PATENT PORTFOLIO LICENSE FOR THE PERSONAL AND NON-COMMERCIAL USE OF A CONSUMER TO

(i) ENCODE VIDEO IN COMPLIANCE WITH THE VC-1 STANDARD (“VC-1 VIDEO”)

AND/OR

For Mac OS

How to use the application on Mac OS

Introduction

Purpose of this manual

This manual explains how to use the XDCAM EX Clip Browsing Software on Mac OS. This manual is intended for users who will use this application to perform file and folder operations. It assumes that readers have a basic familiarity with Mac OS.

Notation for special keys

This manual uses the following notation to indicate special keys.

| Symbol | Notation in this manual |
|--------|-------------------------|
| ⌘ | Command |
| ⇧ | Shift |
| ⌥ | Option |
| ⌘ | Control |
| ↵ | Return |

Notes on use of XDCAM devices

- This software cannot access an XDCAM HD device while another XDCAM-compatible application (XDCAM Transfer/PDZ-1) is accessing that device.
- While running this software, if it becomes necessary to connect/disconnect the i.LINK cable or power on/off the XDCAM device, always do such operations after you exit this software.

Overview

The XDCAM EX Clip Browsing Software allows you to work with clips created with XDCAM EX/XDCAM HD devices.

After installing this application on your computer, you can use its intuitive graphical user interface to organize your clips by copying, moving, and deleting them. You can also perform format conversions, preview the clips, and view their metadata.

This application supports XDCAM EX/XDCAM HD compatible data.¹⁾

1) For XDCAM HD compatible data, executable operations are limited (*see next section*).

New functions supported in Version 2.5

The following table shows the principal new functions supported in Version 2.5.

| Function | Description | Reference |
|--|---|-----------|
| XDCAM HD file operations | You can operate XDCAM HD files (MXF files). However, the operations are limited to copying, deleting, and previewing. | – |
| Converting EX files to MXF files by a copy operation | You can convert XDCAM EX files (MP4 files) to MXF files by only copying them to a folder with MXF attributes. | Page 60 |
| Extended export function | You can convert files to XDCAM MPEG IMX and XDCAM DVCAM format files. | Page 65 |

Hardware and software requirements

Install this application on a computer meeting the following hardware and software requirements.

| Item | Description |
|--------|---|
| OS | Mac OS X 10.4.11 or higher or 10.5.1 or higher ^{a)} |
| CPU | Intel Core 2 Duo Processor 2.0 GHz or higher (Intel Core 2 Duo Processor 2.4 GHz or higher recommended) ^{b)} |
| Memory | 1 GB or more (2 GB or more recommended) |

- a) Mac OS is a trademark of Apple Inc., registered in the U.S. and other countries.
- b) Intel is a registered trademark of Intel Corporation in the United States and other countries. Core is a trademark of Intel Corporation in the United States and other countries.

All product names and brand names are registered trademarks or trademarks of their respective owners.

XDCAM devices supported by the application

This application supports the following XDCAM devices:

| Series name | Model name |
|-------------------------------------|------------|
| XDCAM HD422 (Version 1.2 or higher) | PDW-700 |
| | PDW-740 |
| | PDW-HD1500 |
| XDCAM HD (Version 1.92 or higher) | PDW-F355L |
| | PDW-F335L |
| | PDW-F335K |
| | PDW-F75 |
| XDCAM HD Drive | PDW-U1 |

For Mac OS

Installing the Application

If the MainConcept plug-in software is installed
Update the plug-in software to the latest version (*see page 84*).

You can use the extended export function of the XDCAM EX Clip Browsing Software Version 2.5.

If Version 1.0x is installed

Uninstall Version 1.0x (1.00 or 1.01) (*see page 49*) before you start the installer.

Installing from the CD-ROM

- 1** Insert the supplied CD-ROM into the CD-ROM drive of your computer.
The disc icon appears on your desktop.
- 2** Double click the disc icon.
The contents of the CD-ROM appear.
- 3** Double click index.htm.
The cover page appears in your browser.
- 4** Select and click [MAC OS X] from the XDCAM EX Clip Browsing Software Installer.
Finder starts and ClipBrowser.dmg appears.
- 5** Double click ClipBrowser.dmg.
Finder starts and ClipBrowser.pkg appears.



- 6** Double click ClipBrowser.pkg.
The installation screen appears.



7 Click the [Continue] button.

A license agreement screen appears.

8 Click the [Continue] button.

The following message appears.

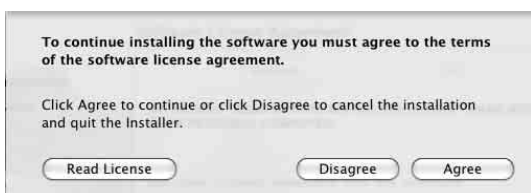

9 Click the [Agree] button.

A screen appears in which you can select the installation destination.

10 Click the installation destination volume.

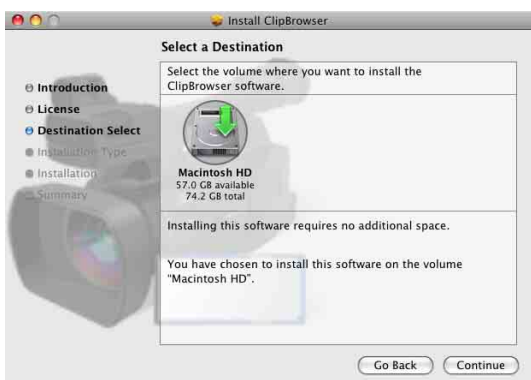

11 Click the [Continue] button.

The following screen appears.



12 Click the [Install] button.

An authentication screen appears.



13 Enter your name and password, and then click the [OK] button.

The following screen appears when the installation finishes.



14 Click the [Close] button to close the dialog.

To uninstall the application

Move the installation destination folder of the application (default: /Applications/XDCAM EX Clip Browser) to the Trash.

Note

Uninstalling the application also uninstalls the MainConcept plug-in software at the same time.

Launching and Exiting the Application

See “Installing the Application” (page 48) for more information about how to install the application.

Launching the application

Use Finder to open the XDCAM EX Clip Browser folder in the Applications folder, and double click XDCAM EX Clip Browser.

The application starts, and the operating windows (*see page 51*) appear.

Note

It is not possible to launch more than one instance of this application at one time.

Exiting the application

Select [Quit XDCAM EX Clip Browser] from the [XDCAM EX Clip Browser] menu.

Note

Do not power off the computer while a file operation is still underway. Files may be corrupted. Wait until the operating finishes, or cancel the operation, before powering off.

Names and Functions of Parts

Operating window configuration

The following figure shows the default configuration of the operating windows.

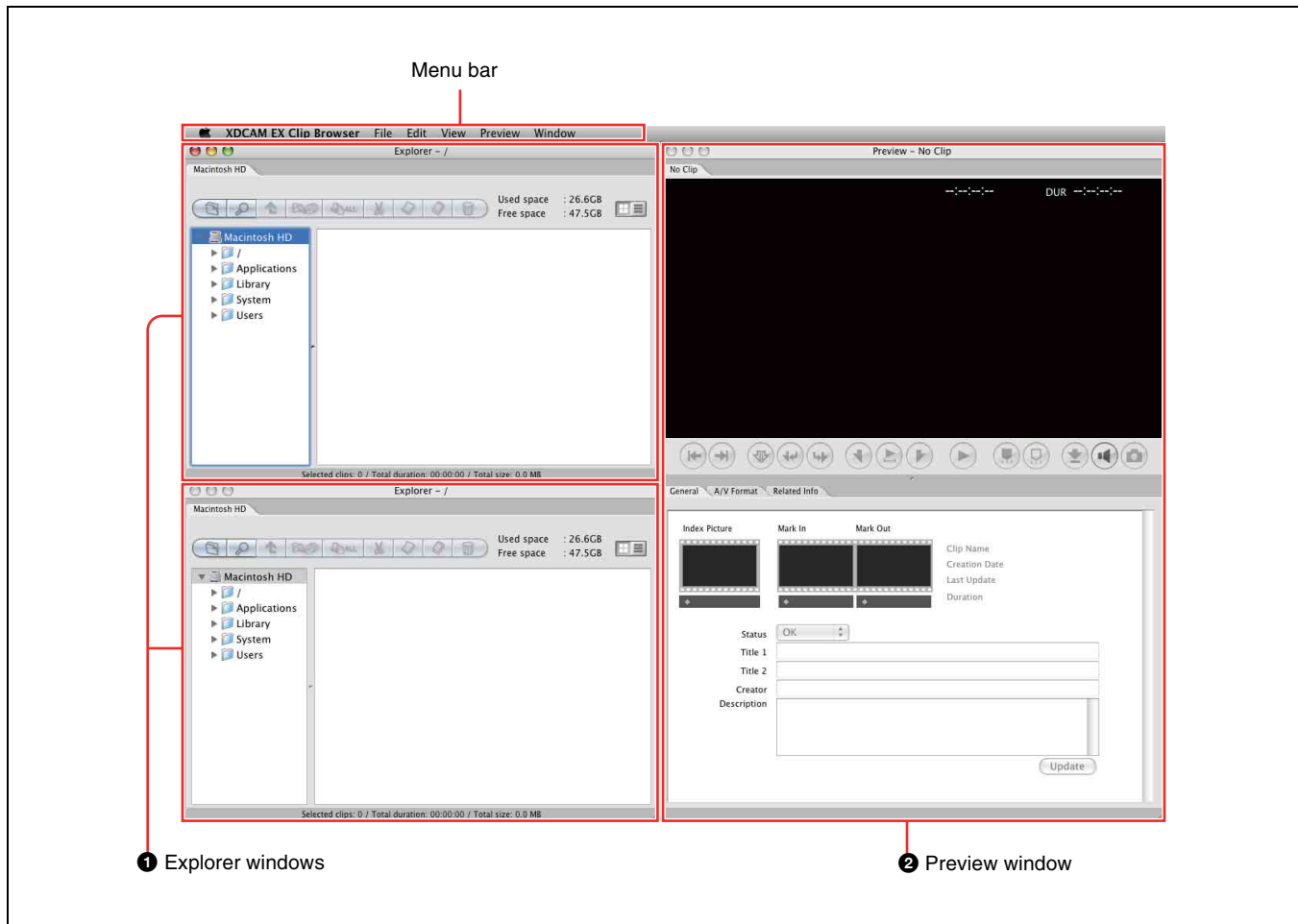

1 Explorer windows

You can have up to ten Explorer windows open at one time. When you have more than one window open, you can convert them into tabs on one window.

For details, see “Explorer window” (page 52).

2 Preview windows

You can have up to five Preview windows open at one time. When you have more than one window open, you can convert them into tabs on one window.

For details, see “Preview window” (page 55).

To customize the window configuration

To open another window

Select [New Explorer Window] or [New Preview Window] from the [File] menu. A new Explorer or Preview window opens.

To snap windows to each other

Drag one of the windows close to another window. The windows snap together when they approach each other.

To tab windows

You can convert windows of the same type (Explorer or Preview) into tabs in a single window.

To tab a window, drag it and drop it on another window.

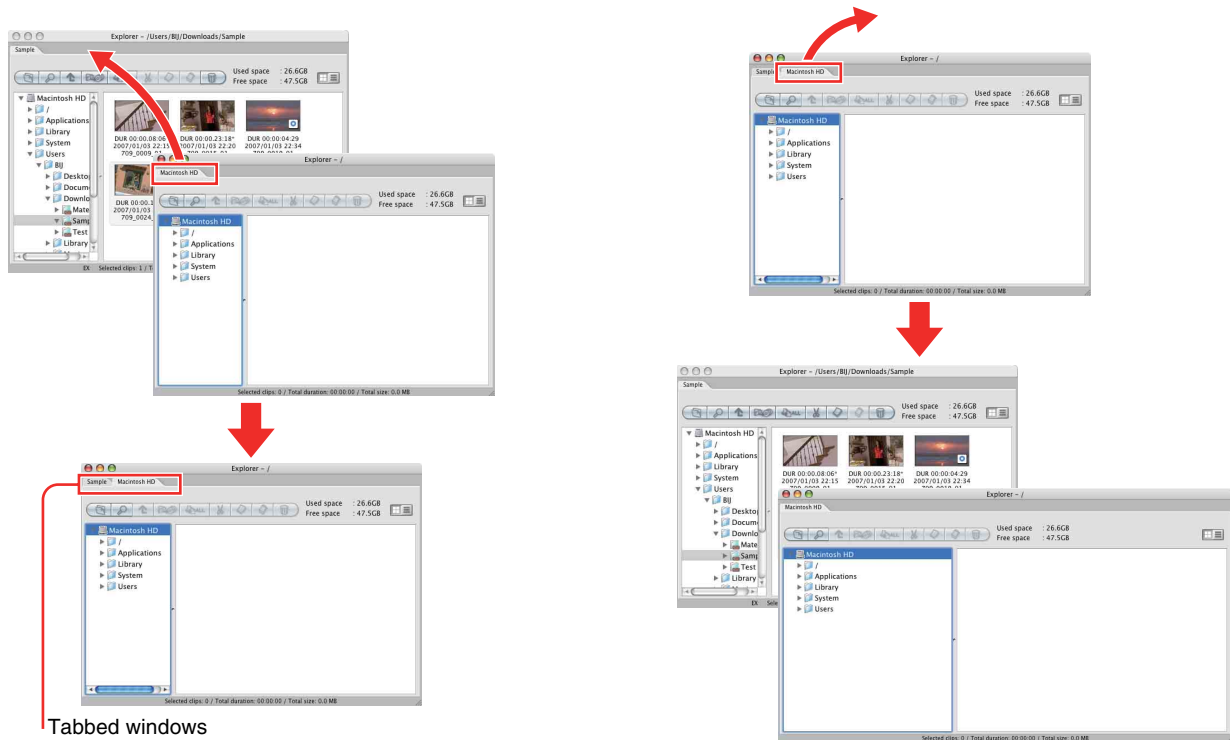

Tabbed windows

When one Preview window is already open, you can open a new Preview tab by doing one of the following in an Explorer window.

- Double click a media file in the List View pane.
- Select a media file in the List View pane, and then select [Play] from the [Preview] menu.

If the selected media file is already loaded into its own Preview window or a Preview tab, that window or tab is activated.

To convert a tabbed window back into a separate window

Drag the tab of the window that you want to separate away from the other window.

Other window operations

- Drag the window title bar to move a window.
- Resize a window by dragging on any window border.
- Maximize a window or return it to its original size by each clicking the + (zoom) button in the upper left corner.
- Close a window you do not need by clicking the x (close) button in the upper left corner.

The application remembers your most recent configuration and recreates it the next time it starts.

Keyboard shortcuts for selecting tabs

You can use keyboard shortcuts to select tabs.

To select the previous or next tab from the keyboard

Press Shift + Command + { or Shift + Command + }.

Explorer window

Explorer windows are where you operate on clips (files) and folders, and where you check clip metadata. You can operate on XDCAM EX/XDCAM HD format folders and media.

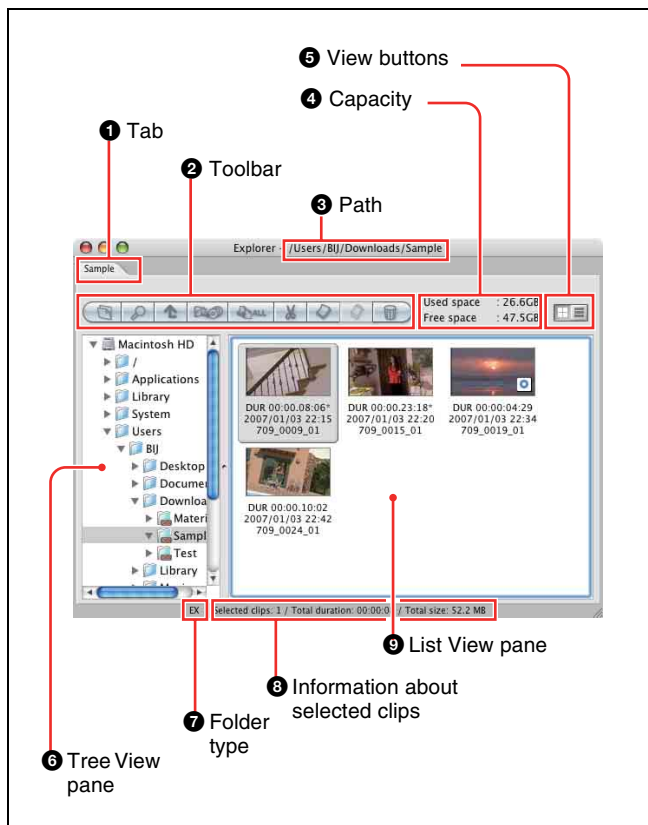

1 Tab

The tab displays the name of the media or folder that is selected in the Tree View pane. When two or more Explorer windows are open, you can drag and drop the tab on another window to convert this window into a tab on the other window (see page 51).

2 Toolbar

Contains tool buttons for operations on clips and folders.

| Tool buttons | | Function | Reference |
|--------------|--------------|---|-----------|
| Icon | Name | | |
| | New Folder | Creates a new folder in the currently selected media or folder. | Page 69 |
| | Find | Opens the Find dialog. | Page 68 |
| | Up | Moves up to the next higher folder. | – |
| | Split Folder | Opens the Split Folder dialog. | Page 71 |
| | Copy All | Copies all of the clips in the selected media or folder to a new folder. This application creates the new folder automatically. | Page 60 |

| Tool buttons | | Function | Reference |
|--------------|--------|--|--------------------|
| Icon | Name | | |
| | Cut | Cut the selected clip. | Page 61 |
| | Copy | Copy the selected clip. | Page 59 |
| | Paste | Pastes a clip that has been cut or copied. This can be used to move a clip to another media or folder. | Page 59 Page 61 |
| | Delete | Delete the selected clip or folder. | Page 62 Page 70 |

3 Path

This is the full path to the media or folder that is selected in the Tree View pane.

4 Capacity

Displays the used capacity and remaining capacity of the media selected in the Tree View pane.

5 View buttons



Selects the List View pane view mode.

| Buttons | | Function |
|---------|------------|--|
| Icon | Name | |
| | Thumbnails | Puts The List View Pane Into Thumbnails View Mode. |
| | Details | Puts The List View Pane Into Details View Mode. |

6 Tree View pane

Displays a tree of media and folders contained in drives. The following icons represent the type of the media or folder.

| Icon | Type of media or folder |
|------|--|
| | Hard disk drive |
| | CD, DVD or Blu-ray Disc drive |
| | XDCAM drive (normal) |
| | XDCAM drive (UserData) |
| | SxS memory card drive |
| | Mass storage device (removable drive) connected by USB |
| | Mounted network drive |

| Icon | Type of media or folder |
|---|--|
|  | Normal folder, not managed by this application |
|  | Folder with EX attributes |
|  | Folder with MXF attributes |

The Tree View pane supports the same kinds of operations as the tree panel of Finder.

Note

When you select a media item, a message may appear saying that salvage is required, and that you should salvage the media on the device that recorded it. This message appears when the data is defective, typically because the XDCAM EX device was powered off or the media was ejected too soon during recording. If this message appears, you should reinsert the media into the XDCAM EX device and attempt to salvage it as soon as possible. The data may become unrecoverable if you continue to work with it without salvaging it.

Media

In this manual, “media” refers to the following media types.

- SxS memory cards
- USB memory
- Internal hard disks
- Externally connected hard disks
- CD-R discs
- DVD-R discs
- Blu-ray discs
- Professional Discs (XDCAM drives)

7 Folder type

Displays the type of the folder being selected in the Tree View pane.

EX: Folder with EX attributes

MXF: Folder with MXF attributes

8 Information about selected clips

Displays information about the clips that are selected in the List View pane (number of selected clips, total clip length, and total size).

Note

The total clip length is an approximate value, so take it as an approximate guide.

9 List View pane

Displays the clips in the media or folder that is selected in the Tree View pane. You can select either of the following view modes.

Thumbnail View: This view displays the index picture of each clip (or a thumbnail of the first frame, when no index picture is set). It also displays the name of the clip and the date and time when the clip was shot.









Details View: This view displays an icon indicating the type and current state of the clip, the name of the clip, and its properties.





To switch the clip view mode

Do one of the following.

- Select [Thumbnails] or [Details] from the [View] menu.
- Click the Thumbnails or Details button in the Explorer window.

A mark for the clip status is displayed on the thumbnail or icon in either of the view modes.

| View mode | Icon | Description |
|--------------|--|---|
| Details view |  | Normal MP4 file |
| |  | MP4 file with OK status (as set on the XDCAM EX device) ^{a)} |
| |  | An MP4 file in which some of the video cannot be displayed. However, other parts of the video can be previewed, and the properties of the MP4 file can be edited like the properties of normal MP4 files. |
| |  | Abnormal MP4 file (without data, cannot be decoded, etc.) |
| |  | Normal MXF file |
| |  | MXF file with OK status (as set on the XDCAM device) ^{a)} |
| |  | An MXF file in which some of the video cannot be displayed. However, other parts of the video can be previewed, and the properties of the MXF file can be edited like the properties of normal MXF files. |
| |  | Abnormal MXF file (without data, cannot be decoded, etc.) |

| View mode | Thumbnail display example | Description |
|-----------------|---|--|
| Thumbnails view |  | Normal clip |
| |  | Clip with OK status (as set on the XDCAM EX device) ^{a)} |
| |  | Part of a clip that spans several media discs or memory devices. ^{b)} |
| |  | A clip in which some of the video cannot be displayed. However, other parts of the video can be previewed, and the properties of the clip can be edited like the properties of normal clips. |
| |  | A clip that cannot be loaded. The clip cannot be previewed, and its properties cannot be edited. ^{c), d)} |

- a) Clips with OK status can be moved or deleted by this application.
b) XDCAM EX devices automatically save video that exceeds 4 GB in size as multiple clips. These clips are parts of the complete recording and can be saved on multiple media. Not all of the original recorded video is played back when a split clip is played back.
c) The file may be corrupt, file links may be broken or changed, required files may be missing, or thumbnail creation may have failed.
d) A clip that cannot be played or displayed properly by this application. Another application is using the clip file.

To sort the View list

Select one of the following items under [Sort By] in the [View] menu.

- Clip Name
- Size
- Duration
- Status
- Creation Date
- Last Update
- Recording Mode
- Media Spanning

To select the items to display in Details View

Open the dialog shown below by selecting [Customize Columns...] from the [View] menu, and then proceed as follows.

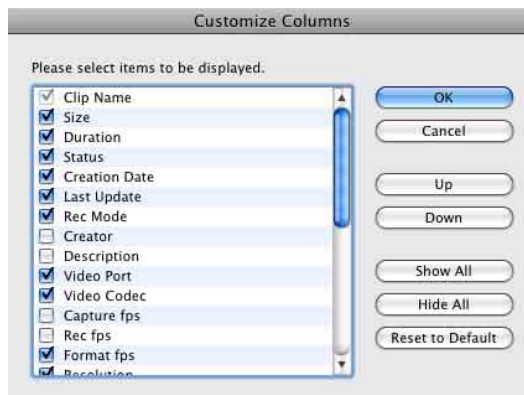

To select an item to display: Check the check box. You can click the [Show All] button to check all of the check boxes.

To select an item to hide: Clear the check box. You can click the [Hide All] button to clear all of the check boxes except “Clip Name”.

To change the display order: Click an item to highlight it, and click the [Up] or [Down] button.

To return to the default settings: Click the [Reset to Default] button.

To confirm the changes: Click the [OK] button.

To cancel the changes: Click the [Cancel] button.

Preview window

Preview windows are where you preview clips and check clip information.

Notes about the Preview window

Playback in this window is preview playback. Note the following points.

- Depending on the performance of your computer and the processing load, dropped frames may occur, timecode may differ from the actual values, the clip may not be played smoothly, and some time may be required before the screen is updated.
- When the playback clip is defective, video breakup may occur and the playback may freeze.
- Not all of the original recorded video is played back when a split clip is played back.
- It may not be possible to play clips created on devices other than XDCAM EX devices.
- Improper playback may occur if the screen settings of your computer are changed during playback. If this occurs, restart the application.

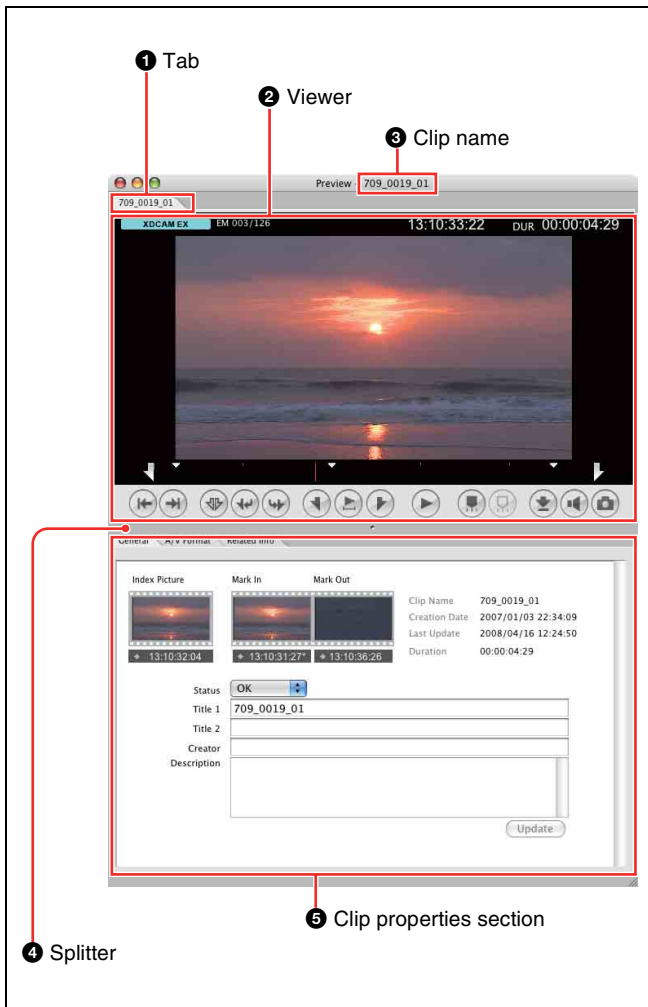
**1 Tab**

Displays the clip name.

When two or more Preview windows are open, you can drag and drop the tab on another window to convert this window into a tab on the other window (*see page 51*).

2 Viewer

Previews clips (*see next section*).

3 Clip name

Displays the clip name of the selected tab.

4 Splitter

You can drag the splitter up and down to change the relative sizes of the viewer and the clip properties section.

5 Clip properties section

Allows you to check clip properties (*see page 58*).

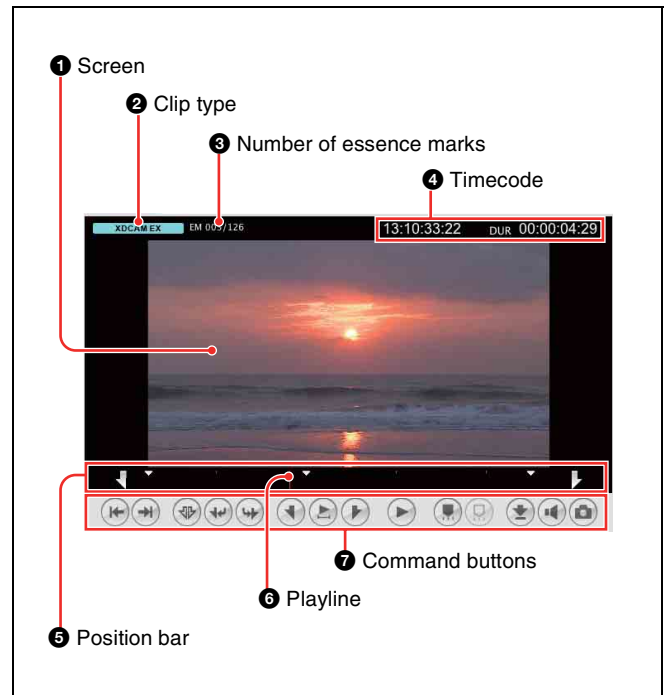
Viewer**1 Screen**

Displays the playback video.

You can double click the screen or select [Full Screen] from the [View] menu to enlarge the size to full screen size.

To return to the original size, double click the screen again or press the Esc key.

2 Clip type

Displays the type of the clip being viewed on the viewer.

XDCAM EX: XDCAM EX clip (MP4 file)

XDCAM HD/HD422: MPEG HD file created from XDCAM HD or XDCAM HD422 clip (MXF file)

XDCAM HD Proxy: Proxy file created from XDCAM HD or XDCAM HD422 clip (MXF file)

3 Number of essence marks

Displays the number of the essence marks set in the clip (in the format of: actually set number/maximum allowable number).

4 Timecode

Displays the timecode of the current position (playline position), and the duration of the section between In and Out points in the clip. A counter value is displayed when no timecode is recorded in the clip.

For NTSC clips, a period (.) between the minutes and seconds of the current position indicates drop-frame, and a colon (:) indicates non-drop-frame.





It is possible to jump to a specified position by clicking the current position timecode, entering a numeric value, and pressing the Return key. (This operation is ignored when invalid timecode is entered.)

You can change the timecode display format. For details, see “User settings” (page 74).

5 Position bar

Displays the time scale of the clip.

The following marks are shown on the position bar to provide information about the clip.

| Mark | Meaning |
|---|---|
|  | In point |
|  | Out point |
|  | Essence mark |
|  | Timecode break point (discontinuous timecode) |







6 Playline









Displays the current position on the time scale.

You can drag the playline or click anywhere on the position bar to move to a desired position. Scrubbing (repeatedly dragging to the left and right) is also supported.

7 Command buttons

These buttons perform various clip preview operations. The functions of these buttons can also be accessed from the keyboard.

| Icon | Button name | Keyboard operation | Function |
|---|---------------------------------|--------------------|---|
|  | Jump to Start | Home | Jumps to the clip start point (first frame). |
|  | Jump to End | End | Jumps to the clip end point (last frame). |
|  | Clear Mark In/Out ^{a)} | Shift + X | Clears In and Out point settings. Can be done during play (play continues). |
|  | Jump to In point | ↑ | Jumps to the In point. |
|  | Jump to Out point | ↓ | Jumps to the Out point. |
|  | Mark In ^{a)} | I | Sets an In point at the current position. Can be done during play (play continues). |

| Icon | Button name | Keyboard operation | Function |
|---|-----------------------------------|--------------------|--|
|  | Play In to Out | Shift + Space | Plays the section from the In point to the Out point. (During play, the button icon lights green.) Stops play if clicked during play. |
|  | Mark Out ^{a)} | O | Sets an Out point at the current position. Can be done during play (play continues). |
|  | Play | Space | Plays the clip. (During play, the button icon lights green.) Stops play if clicked during play. |
|  | Add Essence Mark ^{a)} | E | Adds an essence mark at the current position. ^{b)} Can be done during play (play continues). However, an essence mark cannot be set at a position where one already exists. |
|  | Delete Essence Mark ^{a)} | Shift + E | Deletes the essence mark at the current position. Can be done during play (play continues). |
|  | Set Index Picture | P | Sets the current frame as the index picture of the clip. Can be done during play (play stops). |
|  | Set Audio Channels | – | Opens the Set Audio Channels dialog. |
|  | Capture Still Image | – | Saves the frame at the current position as a bitmap file. This command opens a dialog where you can specify the file name and save destination. However, still images cannot be created from a clip on XDCAM disk. |

a) You cannot use these buttons to apply editing operations on clips existing on the XDCAM drive. These buttons cannot add or delete edit points (In/Out points) or essence marks in those clips.

b) The maximum number of essence marks that you can set in a single clip is as follows, depending on the clip format.

XDCAM EX clip: 126

XDCAM HD clip (less than 126 seconds): the number of seconds + 1 (for example, 46 marks for a 45-second clip)

XDCAM HD clip (126 seconds or more): 126

Clip properties section

General tab

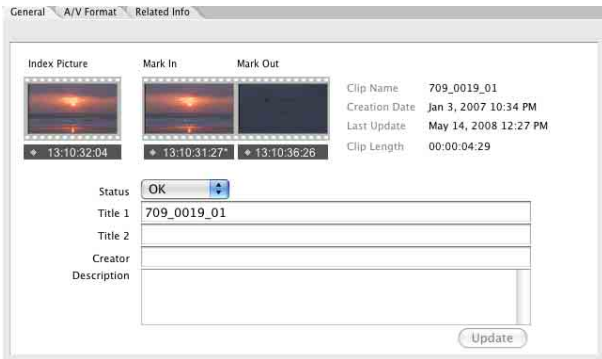

This tab displays general information about the clip.

- **Index Picture:** Displays the index picture of the clip, or a thumbnail of the first frame if no index picture has been set.
- **Mark In:** Displays a thumbnail of the In point, or a thumbnail of the first frame if no In point has been set.
- **Mark Out:** Displays a thumbnail of the Out point, or a thumbnail of the last frame if no Out point has been set.
- **Clip Name**
- **Creation Date** (date and time of creation)
- **Last Update** (date and time of most recent update)
- **Duration** (clip length)
- **Status:** Displays the clip status. You can select the status from among OK, NG, KEEP, and None.
- **Title 1:** Allows you to assign a title up to 63 ASCII bytes in length.
- **Title 2:** Allows you to assign a subtitle up to 127 bytes in length.
- **Creator:** Allows you to enter the name of the person who shot the clip, up to 127 bytes in length.
- **Description:** Allows you to enter a description of the scene depicted in the clip, up to 2047 bytes in length.

To save changes to the Status, Title 1, Title 2, Creator, and Description fields, you must click the Update button. The changes are discarded if you close the window or tab without clicking the Update button.

A/V Format tab

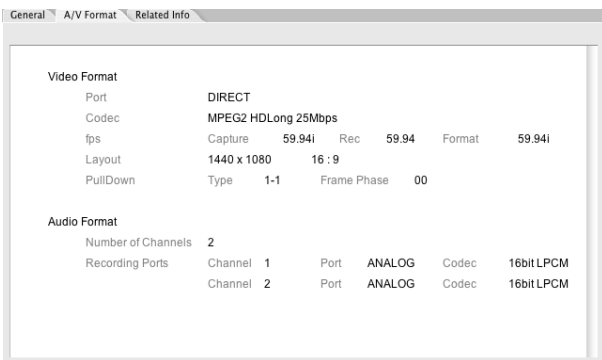

This tab displays information about the recording format of the clip.

- Video Format
- Audio Format

Related Info tab

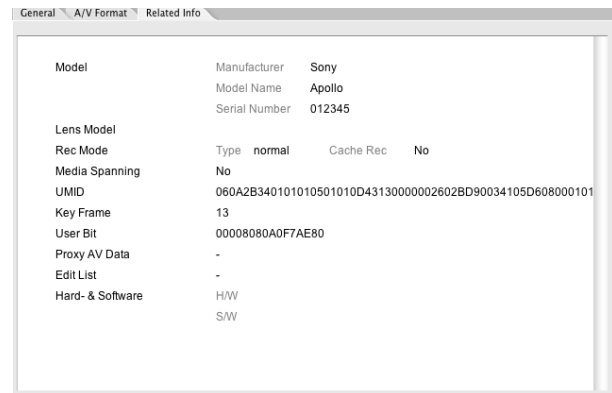

This tab displays information related to clip recording conditions.

- Model
- Lens Model
- Recording Mode
- Media Spanning
- UMID
- Key Frame
- User Bit
- Proxy AV Data
- Edit List
- Hard- & Software

Clip Operations

Clip operation precautions

- Always observe the following precautions during processing of clip operations.
 - Do not power off the computer or media drive before the operation completes.
 - Do not use Finder or another file management tool to delete folders that contain the clips being processed.
 - Do not eject the media before the operation completes.
- It may be possible to copy and move clips to media with this application even when the display on an XDCAM EX device indicates that the media is full. However, it will not be possible to play back or delete those clips when the media is inserted into the XDCAM EX device again (a message will appear saying that the media must be salvaged).
- For the folders created on a hard disk or other media by copying from XDCAM drive with Finder or other folder management tool, editing operations such as adding and deleting of clips cannot be performed.
- When writing clips to XDCAM drive, it is necessary beforehand to set the NAMING FORM option in the XDCAM HD device menu to “free (no format).” If the option is set to “C**** (standard format),” any clip with an arbitrary name other than C**** cannot be written to XDCAM drive.
- Writing a 50p or 60p frame rate clip to XDCAM drive moves the essence marks and Out points at the odd frames to the previous or next even frames. For example, the essence mark at the 15th frame moves to the 14th, while the Out point at the 19th frame moves to the 20th. However, the Out point will be deleted if an essence mark already set at the move destination frame.

For details about the menu operations of the XDCAM HD device, refer to the Operating Instructions or Operation Manual supplied with the XDCAM HD device.

Copying clips

You can duplicate clips on your media or computer, and copy clips between media and the computer.

Note

When copying MXF clips to XDCAM drive or a folder with MXF attributes, it is not possible to copy the clip of a different recording format from that of the clips in the destination.

Grouping split clips by gathering them into one place

XDCAM EX devices automatically save video that exceeds 4 GB in size as multiple clips. If you collect these clips into one media or folder, they are automatically grouped so that you can handle them as a single clip.

See “Grouping clips that have been split across separate media” (page 62) for more information.

To copy selected clips

- 1 Select a clip to copy in the List View pane of an Explorer window.

Notes

- Abnormal clips can be selected, but they are not copied.
- The folder that contains the selected clips cannot be specified as the copy destination.

If you want to copy the clips to a new folder

Create a new folder in the copy destination media or folder.

See “Creating folders” (page 69) for more information about how to create folders.

- 2 Do one of the following.

- Drag the clips selected in step 1 and drop them in the List View pane of another window, or on a copy destination media or folder in the Tree View pane of the same window or another window.
- Click the Copy button. Then click the List View pane of another window, or a copy destination media or folder in the Tree View pane of the same window or another window, and click the Paste button of that window.
- Select [Copy] from the [Edit] menu. Then click the List View pane of another window, or a copy destination media or folder in the Tree View pane of the same window or another window, and select [Paste] from the [Edit] menu.

A message appears asking if you want to execute the copy.



- 3 Click the [Yes] button to execute the copy, or the [No] button to cancel it.

A dialog illustrating the progress of the copying opens when the copying starts.

Note

Once it has been completed, you cannot undo the copy operation.

To cancel the copy operation

Click the [Cancel] button in the progress dialog.

Reasons why a copy operation may fail

Copy operations may fail for the following reasons. In these cases, an error message appears and the copy is not executed.

- There is not enough free capacity at the copy destination.
- A clip with the same name as one of the selected clips already exists at the copy destination. Even if the clip names are different, clips are recognized as the same clip if they share the same ID (UMID).
- You do not have delete/write privileges to the destination media or folders.
- The destination media or folder is write protected.

If you copy an XDCAM EX file to a copy destination with MXF attributes

Copying an XDCAM EX file (MP4 file) to XDCAM drive or an MXF folder automatically converts the file to the XDCAM HD format (MXF file). This makes EX material available on your XDCAM HD device more easily than the export function (*see page 64*).

Copied files have the same recording format as that of the existing files in the destination.¹⁾ However, the bit rates are determined as specified in [Bit Rate] under [MP4 to MXF conversion by copy] in the Conversion tab of the Preferences dialog (*see page 75*).

1) If no file exists in the destination, the bit rate is determined as specified in [Format Settings: when there's no clip in the folder] under [MP4 to MXF conversion by copy] in the Conversion tab of the Preferences dialog.

Supplement

When the [Convert in MXF for copying EX to a normal folder] check box in the General tab of the Preferences dialog (*see page 74*) is checked, even the files which are to be copied to a normal folder are converted to the MXF format. Since the clip management folders for the XDCAM HD device (*see page 73*) are automatically created, the files converted in this application can be viewed. (The files which were output to a normal folder by the export function cannot be viewed in this application.)

Notes

- It is not possible to convert the XDCAM HD files to the XDCAM EX format.

- File conversion is not possible depending on the combination of source format and target format.
- File conversion may degrade the image quality.
- This copy operation takes longer to complete since it requires format conversion.
- XDCAM EX to XDCAM HD format conversion produces only MPEG HD files as MXF files. It does not produce Proxy files.

To copy all the clips in media or folders

You can copy all of the clips in a folder or a media disc or card in a single operation. This is a convenient way to import all the clips in an SxS memory card to the hard disk of your computer.

- 1 In the Tree View pane of an Explorer window, select the media or folder that contains the clips you want to copy.
- 2 Do one of the following.
 - Click the Copy All button.
 - Select [Copy All] from the [Edit] menu.

A message appears asking if you want to execute the copy. Check the destination folder.

You can change the copy destination folder. See “User settings” (page 74) for more information.



- 3 Click the [Yes] button to execute the copy, or the [No] button to cancel it.

A dialog illustrating the progress of the copying opens when the copying starts.

To cancel the copy operation

Click the [Cancel] button in the progress dialog.

Reasons why a copy operation may fail

Copy operations may fail for the following reasons. In these cases, an error message appears and the copy is not executed.

- There is not enough free capacity at the copy destination.
- A clip with the same name as one of the selected clips already exists at the copy destination. Even if the clip names are different, clips are recognized as the same clip if they share the same ID (UMID).
- You do not have delete/write privileges to the destination media or folders.
- The destination media or folder is write protected.

Copy error check option

For greater copy reliability, you can enable the CRC (cyclic redundancy check) error check option. However, copy operations take longer to complete when this option is enabled.

See “User settings” (page 74) for more information about this option.

Moving clips

You can move clips on your media or computer, and move clips between media and the computer.

Notes

- You cannot operate clips in other than XDCAM EX format (for example, XDCAM HD clips). You can operate XDCAM EX clips only.
- Clips with OK status can be moved by this application.

Grouping split clips by gathering them into one place

XDCAM EX devices automatically save video that exceeds 4 GB in size as multiple clips. If you collect these clips into one media or folder, they are automatically grouped so that you can handle them as a single clip.

See “Grouping clips that have been split across separate media” (page 62) for more information.

Move modes

You can specify whether to give priority to processing speed or to data protection when moving clips.

- Processing speed: Normal move processing, without creating a duplicate of the clip.
- Data protection: A duplicate of the clip is created before the original clip is deleted.

See “User settings” (page 74) for more information about the settings.

- 1 Select a clip to move in the List View pane of an Explorer window.

Notes

- Abnormal clips can be selected, but they cannot be moved.
- The folder that contains the selected clips cannot be specified as the move destination.

If you want to move the clips to a new folder

Create a new folder in the move destination media or folder.

See “Creating folders” (page 69) for more information about how to create folders.

- 2 Do one of the following.
 - Drag the clips selected in step 1, and while holding down the Shift key, drop them in the List View pane of another window, or on a copy destination media or folder in the Tree View pane of the same window or another window.
 - Click the Cut button. Then click the List View pane of another window, or a copy destination media or folder in the Tree View pane of the same window or another window, and click the Paste button of that window.
 - Select [Cut] from the [Edit] menu. Then click the List View pane of another window, or a copy destination media or folder in the Tree View pane of the same window or another window, and select [Paste] from the [Edit] menu.

A message appears asking if you want to execute the move.

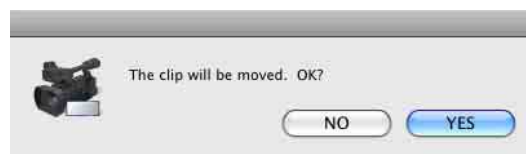

- 3 Click the [Yes] button to execute the move, or the [No] button to cancel it.

A dialog illustrating the progress of the move opens when the move starts.

Notes

- Once it has been completed, you cannot undo the move operation.
- Do not exit this application during the move. Doing so can break the links between clips and their metadata. The link information for split clips can be lost, causing them to become abnormal clips. If the selected clips are important, we recommend that you set the move mode to data protection mode (see page 61).

To cancel the move operation

Click the [Cancel] button in the progress dialog.

Reasons why a move operation may fail

Move operations may fail for the following reasons. In these cases, an error message appears and the move is not executed.

- There is not enough free capacity at the move destination.
- A clip with the same name as one of the selected clips already exists at the move destination. Even if

the clip names are different, clips are recognized as the same clip if they share the same ID (UMID).

- You do not have delete/write privileges to the source or destination media or folder.
- The source or destination media or folder is write protected.

Deleting clips

Notes

- Clips with OK status can be deleted by this application.
- Deleting a clip linked to edit lists deletes all the edit lists linked to the clip.

1 In the List View pane of an Explorer window, select a clip to delete.

2 Do one of the following.

- Press the Delete key with the Command key held down.
- Click the Delete button.
- Select [Delete] from the [Edit] menu.

A message appears asking if you are sure you want to delete the clips.



3 Click the [Yes] button to execute the deletion, or the [No] button to cancel it.

Note

It is not possible to undo the deletion once it has been completed.

Reasons why a delete operation may fail

Deletion operations may fail for the following reasons. In these cases, an error message appears and the deletion is not executed.

- You do not have delete/write privileges to media or folder where the clips are stored.
- The media or folder where the clips are stored is write protected.

Grouping clips that have been split across separate media

When you have split clips that have been saved on separate media as a result of an extended recording session, you can

group those clips by collecting them in a single location. Grouped clips can be handled as a single clip. You can collect split clips by copying them, by moving them, or by combining split folders.

See “Copying clips” (page 59), “Moving clips” (page 61), and “Combining folders” (page 71) for more information about the operations.

Notes

- You cannot operate clips in other than XDCAM EX format (for example, XDCAM HD clips). You can operate XDCAM EX clips only.
- Split clips which are not continuous along the time axis are not grouped.
- Abnormal clips are not grouped.
- Clips with altered UMIDs are not grouped. Grouping is performed on the basis of the UMIDs of split clips, and not on the basis of their file names.

Creating clips by specifying ranges

You can create a new clip by setting In and Out points in an existing clip. The new clip can be handled in the same way as the original clip. This is a convenient way to create clips during online editing.

Note

You cannot operate clips in other than XDCAM EX format (for example, XDCAM HD clips). You can operate XDCAM EX clips only.

1 Preview a clip in a Preview window (*see page 66*), click the Mark In button at the position you want to use as the first frame, and click the Mark Out button at the position you want to use as the last frame.

In and Out points are set in the clip.

Supplement

You can also set the Out point by specifying the In point and duration.

Duration can be specified by clicking the timecode display of the duration, entering a numeric value, and pressing the Return key.

Note

In and Out points cannot be set at the same frame. When you try to set an Out (or In) point at a frame where an In (or Out) point has been set, the Out point is automatically set at the next frame after the In point.

- 2 Play the section specified in step 1, and adjust the In point and Out point positions as required.
- 3 In the List View pane of an Explorer window, find the clip where you set the In and Out points, and click the clip to select it.

To create several clips in one batch operation

You can create several clips in one operation. Carry out steps 1 and 2 in several clips stored in the same folder or on the same media, and then select those clips here.

- 4 From the [File] menu, select [New clip using In/Out section].

A confirmation message appears asking if you want to create the clips.



If the In and Out points are not set

The following message appears. If you choose to continue, the effect is the same as copying the complete original clip.

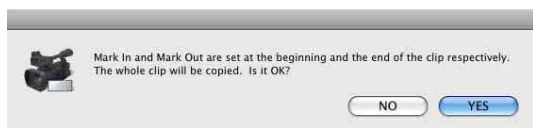

- 5 Click the [Yes] button to create a new clip, or the [No] button to cancel the operation.

A progress dialog opens when creation of the clip starts.

To cancel creation of the clip

Click the [Cancel] button in the progress dialog.

Reasons why a new clip operation may fail

Creation of a new clip may fail for the following reasons. In these cases, an error message appears and the clip is not created.

- There is not enough free capacity at the clip creation destination.
- You do not have delete/write privileges to the destination media or folders.

Importing clips

You can import XDCAM EX format compatible MP4 files and register them as clips that can be handled by XDCAM EX devices.

Note

You cannot operate clips in other than XDCAM EX format (for example, XDCAM HD clips). You can operate XDCAM EX clips only.

- 1 In the Tree View pane of an Explorer window, select the media or folder that contains the MP4 files to be imported.
- 2 Do one of the following.
 - Select [Import...] from the [File] menu.
 - Click the media or folder while holding down the Control key, and select [Import...] from the context menu.

The Import dialog opens.

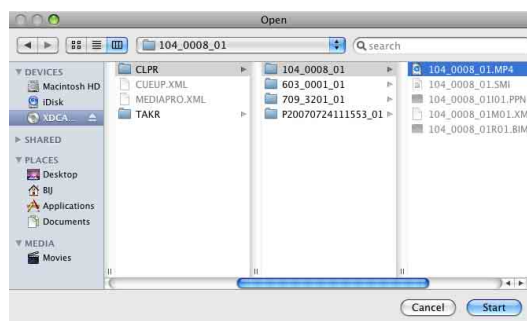

- 3 Select MP4 files to import.
- 4 Click the [Start] button to start the import, or the [Cancel] button to cancel it.

A dialog illustrating the progress of the import operation opens when the import starts.

To cancel the import operation

Click the [Cancel] button in the progress dialog.

Reasons why an import operation may fail

File import operations may fail for the following reasons. In these cases, an error message appears and the files are not imported.

- You do not have delete/write privileges for the import destination media or folder.
- The import destination media or folder is write protected.

Notes

- The properties of imported clips are set automatically.
- The format of imported clips is not fully compatible with the XDCAM EX format. It may not be possible to play imported clips on XDCAM EX devices and with this application.

Exporting clips

You can export files created on XDCAM EX devices for use in various other environments. (To export is to convert files into other formats and output them.)

Future versions will support additional video formats. For upgrade information, visit the website listed in the “Features” section of the Operating Instructions for your XDCAM EX device and on the cover page of the supplied CD-ROM.

Note

You cannot operate clips in other than the XDCAM EX format (for example, XDCAM HD clips). You can operate XDCAM EX clips only.

1 In the List View pane of an Explorer window, select a clip to export by clicking them.

2 Do one of the following.

- From the [File] menu, select [Export] and then select the format that you want to convert to.
- Click the clip while holding down the Control key, from the context menu, select [Export] and then select the format that you want to convert to.

See “File conversion formats” (page 65) for more information about the available conversion formats.

An export dialog opens for the selected format. (The figure below shows the dialog that opens when you choose [MXF for XDCAM HD422].)

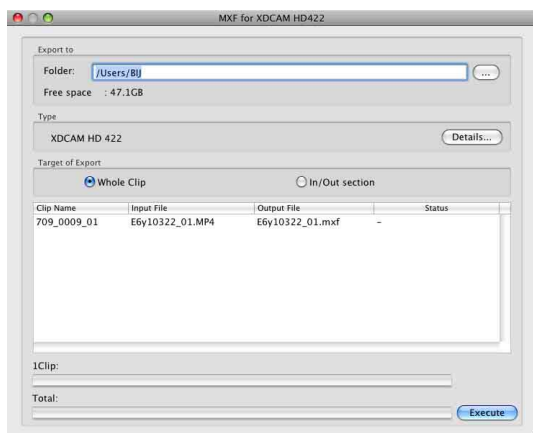

3 Change the following settings as required.

Export to: Specifies the export destination folder. Enter a path beginning with a drive name in the edit box. Or click the [...] button to open a browse dialog where you can select a folder, and then click the [OK] button.

Note

Make sure that the export destination media has adequate free space before you execute the export. An error occurs at the point where the free space is used up.

Type: Click the [Details...] button to open the Codec Detail dialog, set parameters as required, and then click the [OK] button. This item does not appear for some conversion formats.

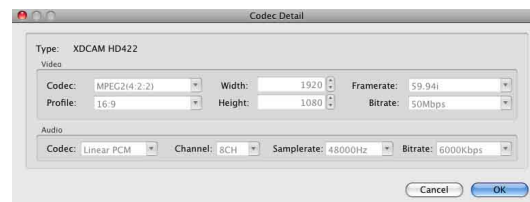

When “1CH” is selected in the [Channel] list box of the [Audio] section, a mixed signal of the channels 1 and 2 is output.

Target of Export: Select [In/Out section] if you want to output the range between the In and Out points in the current clip. This item does not appear for some conversion formats.

To change the output file name

In the List View pane, do one of the following to make the file name changeable.

- Click the file name.
- Click the highlighted part while holding down the Control key to display the context menu and select [Modify the output filename] from the context menu.

| Clip Name | Input File | Output File |
|-------------|-----------------|-------------|
| 709_0009_01 | E6y10322_01.MP4 | E6y10322_01 |

Enter a new name, and press the Return key or click anywhere other than the file name. Extension does not need to be entered.

4 Click the [Execute] button to start the export.

A progress bar appears to show the progress of the export. The progress also appears in the [Status] column of the List View pane.

To cancel the export

Click the [Cancel] button.

If a file with the same name already exists at the output destination

A dialog appears to ask how you want to proceed.

Read the explanation in the dialog and click one of the buttons.

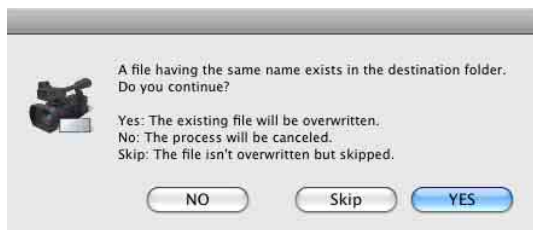

Notes

- The optional MainConcept plug-in software must be installed to use some conversion formats (see page 84). If the plug-in is not installed, a watermark appears in the exported video, and audio is saved for the first 30 seconds only (the subsequent audio is muted).
- Depending on the specified parameters, image quality may be degraded due to the image compensation process.
- Converted files may not be exactly the same with native files in the target format.
- Video metadata may not be inherited after format conversion.
- Image quality may be degraded if format conversion requires re-encoding.
- Image quality may be degraded and duration may vary if files are converted to a format with a different bit rate, resolution, or frame rate parameters.
- Before exporting, ensure that the export destination media or folder is write enabled.

File conversion formats

File conversion formats can be selected with the Export subcommands in the following table.

| Export subcommand | Extension after conversion | Description |
|---------------------------------------|----------------------------|--|
| MXF for NLEs ^{a)} | mxf | Converts to MXF file format without changing the bit rate, resolution or other parameters. This is for non-linear editors that support MXF files only. |
| MXF for XDCAM HD ^{b), c)} | mxf | Converts to an MXF format that is compatible with MXF files recorded by XDCAM HD devices. |
| MXF for XDCAM HD422 ^{b), d)} | mxf | Converts to an MXF format that is compatible with MXF files recorded by XDCAM HD422 devices. |
| MXF for XDCAM MPEG IMX ^{e)} | mxf | Converts to an MXF format that is compatible with MXF files recorded by XDCAM MPEG IMX devices. |

| Export subcommand | Extension after conversion | Description |
|------------------------------------|----------------------------|--|
| MXF for XDCAM DVCAM ^{e)} | mxf | Converts to an MXF format that is compatible with MXF files recorded by XDCAM DVCAM devices. |
| Raw DV | dv | Converts to RAW DV format. This is for DV format editing. Depending on the editing environment, use either this subcommand or the [AVI DV] subcommand. |
| AVI DV | avi | Converts to AVI Type-2 format. This is for DV format editing. Depending on the editing environment, use either this subcommand or the [RAW DV] subcommand. |
| Avid AAF ^{f)} | AAF/mxf | Converts to the following two file formats. AAF file: Use to load clips into Avid editing system. The extension is AAF, and the output destination is the media or folder specified in the Export dialog (see page 64). AAF files produced by the conversion can be registered in your Avid editing system project by dragging from Finder to a bin in the project. MXF OPAtom file: The extension is mxf, and the output destination is the media or folder specified in the Conversion tab of the Preferences dialog (see page 75). Normally this is the media folder of your Avid editing system project. <i>For details, refer to the user's manual of your editing system.</i> |
| Windows Media File | wmv | Converts to Windows Media Player 9 compatible format. |
| Sony PSP (H.264/AVC) ^{g)} | mp4 | Converts to a format that allows clips to be previewed on the PlayStation Portable (PSP) game console from Sony Computer Entertainment. |

| Export subcommand | Extension after conversion | Description |
|--------------------------------------|----------------------------|--|
| Apple iPod (H.264/AVC) ^{g)} | mp4 | Converts to a format that allows clips to be previewed on the iPod portable media player from Apple Inc. |
| Video hosting service | wmv | Converts to a format optimized for Internet video hosting services. |

- a) When outputting the range between the In and Out points in the current clip, the duration may be prolonged after conversion.
- b) Clips of two seconds or less can be converted to MXF files, but they cannot be written to export destination devices.
- c) 23.98p clips can only be converted to a format with the same frame rate (23.98p).
- d) 23.98p clips cannot be converted.
- e) This application supports copying, deleting, and viewing properties of XDCAM MPEG IMX or XDCAM DVCAM clips. It does not support previewing and the other operations. Thumbnail creation fails.
- f) Avid editing systems may refuse to import a clip that has already been exported to the editing system.
- g) Improper playback may occur if the converted file is viewed on a viewer other than the specified devices.

Previewing clips

You can preview clips in the Preview window. Several limitations apply to playback in the Preview window.

For details, see “Notes about the Preview window” (page 55).

To load clips in the Preview window

Display the clip that you want to preview in the Clip View pane of an Explorer window, and then do one of the following.

- Double click the clip.
- Click the clip and then press the Return key.
- Drag and drop the clip on a Preview window (this operation is disabled if multiple clips are selected).
- Click the clip while holding down the Control key, and select [Play] from the context menu.
- Click the clip and then press the space key.

The clip is loaded into a Preview window (and, when the fourth or fifth operation as stated above has been done, the playback starts). The timecode of the current playback position (or a counter value) appears in the upper part of the screen, together with the duration of the section between In and Out points in the clip.

To stop play

Click the play button.

Note

Smooth playback is not possible when previewing clips saved to DVD-R or CD-R discs.

To control the preview

You can use the following methods to control playback in the Preview window.

- Use the command buttons (see page 57) in the Viewer window.
- Select an operation from the [Preview] menu.
- Drag the playline.
- Press the J, K, or L key.
 - J:** Change the reverse playback speed. Each press selects -1, -2, -4, -8, or -16 times normal speed.
 - K:** Stop playback.
 - L:** Change the forward playback speed. Each press selects 1, 2, 4, 8, or 16 times normal speed.

Note

No audio is output in playback at speeds greater than ± 4 times normal speed.

To select full-screen playback

Double click the screen, or select [Full Screen] from the [View] menu.

To return to the original screen size, double click the screen or press the Esc key.

To change the playback mode of MXF clips

Select “MPEG HD (high resolution)” or “Proxy (low resolution)” in the Play tab of the Preferences dialog (see page 75).

Selecting “MPEG HD” makes it possible to preview high definition images when the screen size is enlarged.

Notes

- You cannot change the playback mode when a clip is being played.
- Clips without proxy AV data are played at high resolution regardless of this setting.
- Clips on XDCAM drive are played at low resolution regardless of this setting.
- High resolution data may not be played smoothly due to its large file size.

To select the audio channels to monitor during previews

In the Set Audio Channels dialog, check the L (left) or R (right) check box to monitor that channel.

To open the Set Audio Channels dialog, do one of the following.

- Select [Set Audio Channels...] from the [Preview] menu.
- Click the Set Audio Channels button.

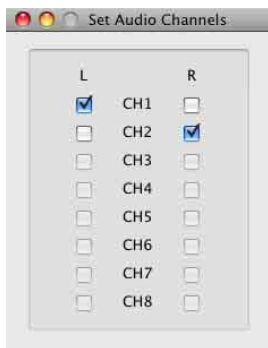

To edit essence marks

Use the Edit Essence Marks dialog.

To open the Edit Essence Marks dialog, load a clip into a Preview window, and activate the Preview window. Then select [Edit] and then select [Edit Essence Marks...] from the [Preview] menu.

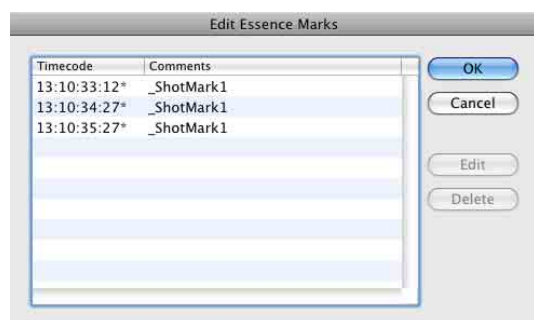

Note

Essence marks in clips on XDCAM drives cannot be edited.

To edit a comment: Select an essence mark in the list and click the [Edit] button. This opens the Edit Comments dialog. Edit the comment in the dialog and click the [OK] button. The maximum length of comments is 32 bytes. The edited comment appears in the Comment field of the Edit Essence Marks dialog.



To delete an essence mark: Select an essence mark in the list (you can select multiple essence marks by selecting with the Shift key held down) and press the [Delete] button.

To confirm changes: Click the [OK] button in the Edit Essence Marks dialog.

To discard changes: Click the [Cancel] button in the Edit Essence Marks dialog.

Notes

- The only essence marks that can be displayed on XDCAM EX devices are “_ShotMark1” and “_ShotMark2”.
- During playback on XDCAM EX devices, essence marks set by this application are displayed next to the frames where they were set.

Changing the index picture of a clip

You can change index pictures during clip previews.

- 1 Play a clip, and display the frame you want to use as the index picture.
- 2 Select [Edit] and then select [Set Index Picture] from the [Preview] menu, or click the Set Index Picture button.

The currently displayed frame becomes the clip’s index picture, and the Index Picture in the General tab of the clip properties section changes to show it.

Notes

- If you are previewing a clip that is stored on removable media, do not eject the media until the operation finishes.
- Do not power the computer off until the operation finishes.
- On XDCAM EX devices, a frame near the specified frame may be displayed as the index picture, instead of the specified frame itself.

Creating still images

- 1 Play a clip in a Preview window, and stop at the scene you want to use as the still image.
- 2 Do one of the following.
 - Press the Capture Still Image button.
 - Select [Capture Still Image...] from the [File] menu.

A dialog opens in which you can specify the file name and storage destination.

- 3 Specify the file name and storage destination and click the [OK] button.

A bitmap still image is created from the frame selected in step 2.

Note

It is not possible to create still images from a clip on XDCAM disk.

Searching for clips

You can search for a clip in either of the following ways, depending on whether you know where the clip is located.

Folder search: When you know where the clip is located, you can search a specified folder for clips with specified properties.

Keyword search: When you know only the fact that the clip is located on the computer on which this application is installed, you can perform a keyword search.

Note

Always observe the following precautions during a search.

- Do not delete the target folder.
- Do not eject the target media.

1 Activate a Preview window and do one of the following.

- Click the Find button.
- Select [Find] and then select [Find...] from the [Edit] menu.

The Find dialog opens.

2 Specify search criteria.

Specified Folder tab

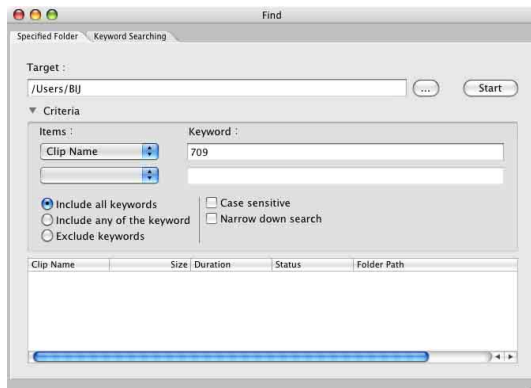

To search a different folder: Click the [...] button to open a browse dialog, select the target folder, and click the [OK] button.

To specify search criteria: Select at least one item from the [Items] list, and enter the matching condition in the text box for that item, or select the condition from the list.

To specify the type of search: Click “Include all keywords” (AND search), “Include any of the

keywords” (OR search), or “Exclude keywords” (NOT search).

To specify search options: As required, check “Case sensitive” and “Narrow down search” (narrow down the search within the results of the previous search).

Note

When [Clip Name] is selected from the [Items] list, search is performed based on the [Clip Name] settings in the Display tab of the Preferences dialog.

Keyword Searching tab

Notes

- Keyword search uses the Mac OS Spotlight which is an indexed search system. The index is updated at times when the computer is not being used for other tasks. Therefore, even if clips exist on the hard disk of the computer, they will not be found if they have not yet been indexed.
- The drives of XDCAM HD devices are not searched.

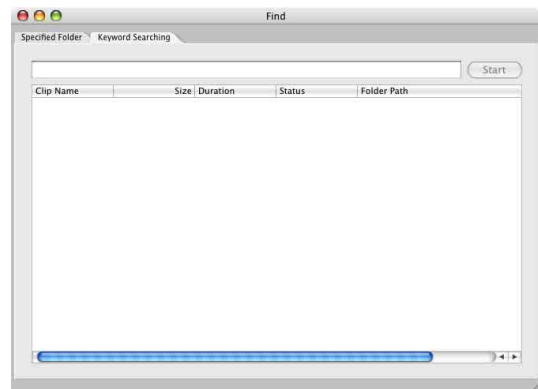

To specify the keywords to find: Enter the keywords to find in the Keywords box. You can enter multiple keywords. An AND search is performed (partial match). Uppercase and lowercase are not distinguished.

3 Click the Start button.

A list of search results appears in the Find dialog, containing clips that match the conditions specified in step 2.

To hide the search criteria in the Specified Folder tab

Click the “-” button.

Click the “+” button when conditions are hidden to show them again.

To sort the search results

Click the header of the column that you want to use as the sort key.

With each click, the list is sorted in ascending or descending order.

To display the search results in an Explorer window

Select one of the search results and do one of the following.

- From the [Edit] menu, select [Find] and then select [Go to Explorer].
- Click the result while holding down the Control key, and select [Go to Explorer] from the context menu.

To play the search results

Select one of the search results and do one of the following.

- Select [Play] from the [Preview] menu.
- Click the result while holding down the Control key, and select [Play] from the context menu.

Folder and Media Operations

Folder and media precautions

Always observe the following precautions during processing of folder and media operations.

- Do not power off the computer or media drive before the operation completes.
- Do not eject the media before the operation completes.

Folders for XDCAM EX clips

XDCAM EX clips are stored together with a BPAV folder (*see page 73*). (This folder does not appear in the Explorer window, but it can be seen in Finder.)

Whenever you copy or move clips with this application, the BPAV folder is copied or moved along with the clips. You cannot work with clips separately from the BPAV folder.

Note

Simultaneous access to files may not be possible when you attempt to access the same folder at the same time from several computers over a network connection.

Folders for MXF clips

A folder for managing MXF clips must have three subfolders: Clip, Edit, and Sub (*see page 73*). Clips cannot be saved in the Clip subfolder unless they match the clips existing in that subfolder in terms of the following characteristics.

- Frame rate (NTSC/PAL/24p)
- Codec (MPEG IMX/DVCAM/HD4:2:0/HD4:2:2)
- Resolution width (coincidence of resolution height not required).
- Bit rate when the codec is MPEG IMX

These conditions are determined by the format of the clip first saved in the Clip subfolder. When copying MXF clips, it is necessary to check the source clips and the clips existing in the copy destination folder to be sure that these conditions are satisfied.

Creating folders

- 1 In the Tree View pane of an Explorer window, select the media or folder where you want to create the folder.

2 Do one of the following.

- Click the New Folder button.
- From the [File] menu, select [Folder] and then select [New Folder].
- Click the media or folder while holding down the Control key, and select [New Folder] from the context menu.

A new folder is created in the media or folder selected in step 1.

Reasons why folder creation may fail

Folder creation operations may fail for the following reasons. In these cases, an error message appears and the folder is not created.

- You do not have write privileges for the selected media or folder.
- The selected media or folder is write protected.

Notes

- Folders cannot be created when writing is not allowed by the computer file system.
- New folders are created as normal folders. But when even one clip is copied or moved to the new folder, the folder is formatted as an XDCAM EX or XDCAM HD work folder. (The required subfolders and metadata files are created automatically.)

To rename a folder

1 Select a folder and do one of the following.

- From the [File] menu, select [Folder] and then select [Rename].
- Click the folder while holding down the Control key, and select [Rename] from the context menu.

The folder name is selected, so that now you can edit the name.

2 Enter a new name, and then press the Return key or click somewhere outside the folder name.

Notes

- The name “BPAV” is reserved and cannot be specified.
- Characters forbidden by the operating system cannot be used in folder names.
- A folder name comprised of 200 or more characters may not be recognized.

To back up folders

1 In the Tree View pane of an Explorer window, select the folder that you want to back up.

2 Do one of the following.

- Select [Show in Finder...] from the [File] menu.
- Click the folder while holding down the Control key, and select [Show in Finder...] from the context menu.

Finder starts.

3 Perform your backup operations in Finder by copying the folder to other media or to another folder.

When a folder is too large to save to your backup media

You can split the folder into smaller folders, and save them on separate discs. Split folders can later be combined to restore the original large folder.

See “*Splitting folders*” (page 71) and “*Combining folders*” (page 71) for more information.

Deleting folders

1 In the Tree View pane of an Explorer window, select the folder to delete.

2 Do one of the following.

- Press the Delete key with the Command key held down.
- Click the Delete button.
- Select [Delete] from the [Edit] menu.
- Click the folder while holding down the Control key, and select [Delete] from the context menu.

A message appears asking if you want to execute the deletion.



3 Click the [Yes] button to execute the deletion, or the [No] button to cancel it.

Reasons why a folder deletion may fail

Folder deletion operations may fail for the following reasons. In these cases, an error message appears and folder is not deleted.

- You do not have delete/write privileges for the selected folder.
- The selected folder is write protected.
- Clips or other folders exist beneath the selected folder.¹⁾

Notes

- Be careful when deleting folders, because all data in the folder is deleted.
- Deletions cannot be undone after they finish.

1) The following examples show two situations in which a folder (Work1) cannot be deleted.

When there is a file that is not managed by XDCAM EX devices

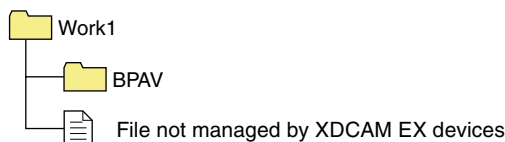

When there is another folder (Work2)

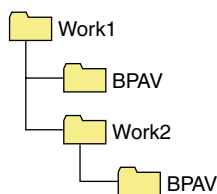

Normally, files which are not managed by XDCAM EX devices and folders such as Work2 must be deleted before the folder Work1 can be deleted. However, if you use Finder to create a folder or file in Work1 while this application is running, then Work1 may be deleted even while the folder or file still exists.

Splitting folders

You can split large folders into smaller folders. This allows you to back up all of the clips in a large folder to media that is not large enough to save the entire folder without splitting.

For example, you can split an 8 GB folder into two 4 GB folders in order to save them on 4 GB DVD-R media. Note that individual files in the large folder are not split.

Note

You cannot operate clips in other than XDCAM EX format (for example, XDCAM HD clips). You can operate XDCAM EX clips only.

- 1 In the Tree View pane of an Explorer window, select the folder to split.

- 2 Do one of the following.

- Click the Split Folder button.
- Select [Split Folder...] from the [Edit] menu.
- Click the folder while holding down the Control key, and select [Split Folder...] from the context menu.

The Split Folder dialog opens.

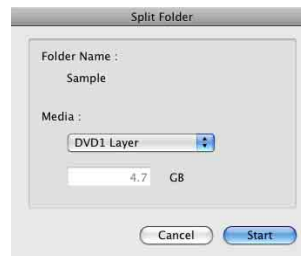

Note

The individual files in split folders are not split. Clips are assigned to the split folders in such a way that the split folders have the specified size. This means that it is not possible to specify a split folder size smaller than the largest file in the original folder. It is also not possible to specify a split folder size smaller than 4 GB.

- 3 Select the type of media from the [Media] list box.

The size of the folder after splitting, as determined by the selected media type, appears in the edit box beneath the list box.

If you select “Arbitrary Size”, enter the size (an integer from 4 to 100) in the edit box.

- 4 Click the [Start] button.

The folder is split into the minimum number of folders that will produce the specified folder size, and clips are assigned to the smaller folders. The folders produced as a result of the split have the same name as the original folder, followed by serial numbers.

Notes

- Once it starts, a split operation cannot be canceled before it finishes.
- Split clips may be assigned to different folders. If you would prefer that split clips be assigned to other folders, you can move them manually after the folder split.

Combining folders

You can combine specified folders into another folder. This allows you to restore the original folder from split folders.

Notes

- You cannot operate clips in other than XDCAM EX format (for example, XDCAM HD clips). You can operate XDCAM EX clips only.
- To become the target of combination, folders must reside on the same directory level and be under the management of this application (*see page 73*).

1 In the Tree View pane of an Explorer window, select the destination folder, into which the other folders will be combined.

2 Do one of the following.

- Select [Combine...] from the [Edit] menu.
- Click the folder while holding down the Control key, and select [Combine...] from the context menu.



3 Check the check boxes of the folders that you want to combine into the folder selected in step **1**. Check the [Delete folders after combine] check box if you want to delete the combined folders after the combine.

Note

The combined folders are not deleted when:

- They contain other folders.
- You do not have delete/write privileges to the original folders.
- The folders are write protected.

4 Click the [Start] button.

The folders selected in step **3** are combined into the destination folder specified in step **1**. The clips in all of the folders are gathered into the destination folder. If any of the clips are split clips, they are automatically grouped, allowing them to be handled as a single clip.

Reasons why a folder combine operation may fail

Folder combine operations may fail for the following reasons. In these cases, an error message appears and the combine is not executed.

- There is not enough free capacity in the combine destination folder.
- You do not have write privileges to the source or destination folders.
- The source or destination folders are write protected.
- Multiple instances of the same clip exist.

Checking/editing disc metadata

You can check and edit the disc metadata (DISCMETA.XML) (*see page 73*) saved on XDCAM drives or in folders with MXF attributes.

1 In the Tree View pane of an Explorer window, select an XDCAM drive or a folder with MXF attributes.

2 Do one of the following.

- Select [Edit Disc Metadata...] from the [Edit] menu.
- Right click the XDCAM drive or folder with MXF attributes and select [Edit Disc Metadata...] from the context menu.

The Edit Disc Metadata dialog opens.

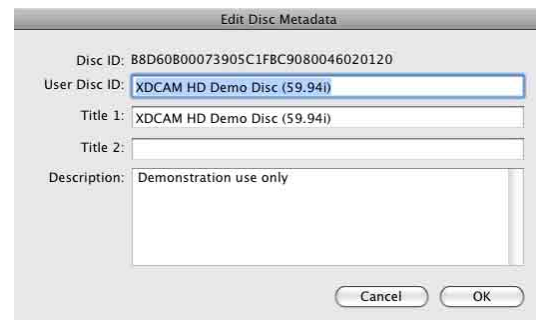

3 Edit the following items as required.

- User Disc ID (up to 127 bytes)
- Title 1 (up to 63 bytes)
- Title 2 (up to 127 bytes)
- Description (up to 2047 bytes)

4 Click the [OK] button.

Appendix

How XDCAM EX clip data are configured

Recording format

This application supports the format specified for XDCAM EX devices. This format has the following specifications.

- Folder names and the folder configuration are as shown in the following figure.
- Files contain link information pertaining to links between files and folders.

Notes

- Do not use tools that do not support the XDCAM EX format to edit, delete, move, or rename the files and folders used by this application. Unless the format specifications are observed, files can become unreadable by XDCAM EX devices and by this application.
- It may not be possible for XDCAM EX devices to play clips that this application has created on, copied to, or moved to media other than SxS PRO memory cards.

Recording folders

The configuration of video and metadata folders is as shown in the following figure.

In the XDCAM EX format, the data beneath the BPAV folder is handled as a single set of data.

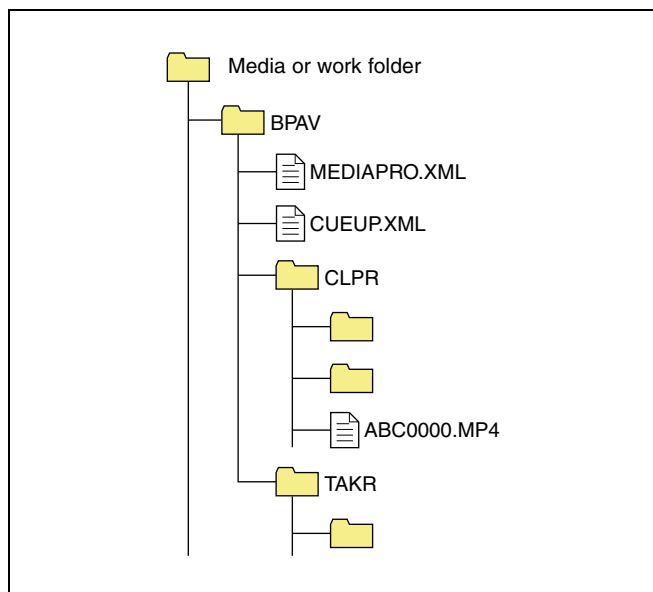

- One BPAV folder exists when a work folder is opened in Finder.

- To copy and backup your data, select the folders beneath the BPAV folder.
- When a work folder is selected in a Tree View pane of Explorer window, a list of clips registered in the BPAV folder appears in the corresponding List View pane. AV data is saved in the folders beneath the CLPR folder.
- On the media used by XDCAM EX devices, the BPAV folder is created beneath the root folder of the media.
- When a work folder is selected in a Tree View pane of Explorer window and the CLPR folder in the work folder has some MP4 files, new folders are created beneath the CLPR folder, and the MP4 files are moved to those folders (the effect is the same as importing the MP4 files).¹⁾
- When MP4 files are imported to a work folder, new folders are created beneath the CLPR folder, and the imported clips are moved to those folders. Folder names are assigned automatically.
- On SxS memory cards and the PHU-60 Professional Hard Disk Unit, up to 600 clips can be registered in one recording folder.

1) This process does not work in the UserData folders on XDCAM drives.

Note

Folder and file names are linked to metadata files. Do not change them.

How MXF clip data are configured

Recording format

This application supports the format specified for XDCAM HD devices. This format has the following specifications.

- Folder names and the folder configuration are as shown in the following figure.
- Files contain link information pertaining to links between files and folders.

Notes

- Do not use tools that do not support the XDCAM HD format to edit, delete, move, or rename the files and folders used by this application. Unless the format specifications are observed, files can become unreadable by XDCAM HD devices and by this application.
- It may not be possible for XDCAM HD devices to play clips that this application has created on, copied to, or moved to media other than Professional Discs (XDCAM drives).

Recording folders

The configuration of video and metadata folders is as shown in the following figure.

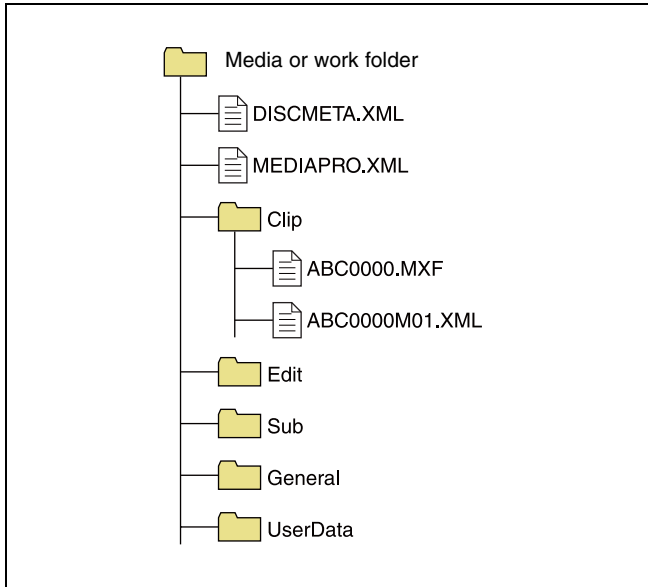

- This application recognizes a folder containing the three subfolders -- Clip, Edit, and Sub -- as a folder with MXF attributes, and browses the Clip folder.
- If XDCAM Drive in the General tab of the Preferences dialog is set to “UserData,” this application browses the UserData folder instead of the Clip folder (*see page 74*).
- If file format conversion is executed by copying files to a normal folder (*see page 60*), DISCMETA.XML and MEDIAPRO.XML files, and Clip, Edit, Sub, and General folders are automatically created, and then the format-converted files are copied to the Clip folder. (For example, when the file named ABC0000.MP4 is copied to a work folder, the format is converted to MXF and the files named ABC0000.MXF and ABC0000M01.XML are automatically created and saved in the Clip folder.)

Notes

- Folder and file names are linked to metadata files. Do not change them.
- Even if you configure clip data like MXF clip data in an EX folder using Finder or other file management tools, this application gives priority to the XDCAM EX format so that you cannot operate MXF clips.

For details about the data configuration for MXF clips, refer to the Operating Instructions or Operation Manual supplied with the XDCAM HD device.

User settings

The Preferences dialog allows you to select application options and processing modes.

To open the Preferences dialog, select [Preferences...] from the [XDCAM EX Clip Browser] menu.

General tab



Priority in Move: Specifies whether to give priority to operating speed or data protection when moving clips (*see page 61*).

- Processing speed: Normal move processing, without creating a duplicate of the clip
- Data protection: Creation of a duplicate before deletion of the original clip

Convert in MXF for copying EX to a normal folder:

When EX format files are copied to a normal folder (without EX or MXF attributes) with this check box checked, the copies are automatically converted to the MXF format.

Perform CRC check after copy: When this check box is checked, the application performs a CRC (cyclic redundancy check) error check after copying a file, and displays a message if a copy error is detected.

Copy all files to: Specifies the destination folder for the Copy All command that copies all clips in a folder or on a media disc or memory card (*see page 60*). Enter a path beginning with a drive name in the edit box. Or click the [...] button to open a browse dialog, select a folder, and click the [OK] button.

Clip ID: Specifies up to four characters added to the start of imported clip names, and to the name of the folder where the imported clips are saved (*see page 63*).

XDCAM Drive: Specifies the folder on an XDCAM drive that this application will use.

- Clip: Uses the Clip folder. In this mode, only MXF clips on the XDCAM drive can be operated (XDCAM EX clips cannot be operated). An “XDCAM Drive (normal)” icon is displayed in the Tree View pane (*see page 53*).
- UserData: Uses the UserData folder. In this mode, only XDCAM EX clips on the XDCAM drive can be operated (MXF clips cannot be operated). This mode is for backup of XDCAM EX clips.

An “XDCAM drive (UserData)” icon is displayed in the Tree View pane (see page 53).

For details about the data management structure for the XDCAM drive available in this application, see page 73.

Display tab



Clip Name: Specifies what to display as the clip name for each clip type.

- By Title: Displays the title as the clip name.
- By Filename: Displays the file name as the clip name.

Note

Even if “By Title” is selected, the file name is displayed for a clip with no title assigned.

50p/60p Timecode Display Mode: Specifies the timecode display format when the frame frequency of the playback clip is 50p or 60p.

- Show all frames: The frame number increases on each frame. (Example of frame number display for 60p clips: 00 → 01 → 02 → ... → 58 → 59 → 00 → ...)
- Show *: The frame number increases on every second frame. An asterisk (*) is added to indicate the second frame in each frame number pair. (This is the display format used by Sony VTRs.) (Example of frame number display for 60p clips: 00 → 00* → 01 → ... → 29 → 29* → 00 → ...)

When no more clips can be previewed: Specifies what to do when the number of clips in Preview windows (simultaneously open windows or tabs) exceeds the number that can be previewed at one time.

- Show a warning.

Play tab



Resolution: Specifies the preview playback resolution.

- Auto: Decodes the playback video at a resolution which is automatically adjusted to match the screen size.
- Normal: Decodes the playback video at the original resolution of the clip, regardless of the screen size.
- 1/2, 1/4: Decodes the playback video at half or quarter resolution. The image quality is lower, but response is better because of the lower demands placed on the decoder.
- Replace the clip that was viewed first.

MXF Play mode: Specifies the playback mode of MXF clips from among the following.

- MPEG HD: Plays the clips at high resolution (plays MXF clips as is).
- Proxy: Plays the clips at low resolution (plays the proxy AV data).

For notes on the playback mode of MXF clips, see page 66.

Conversion tab

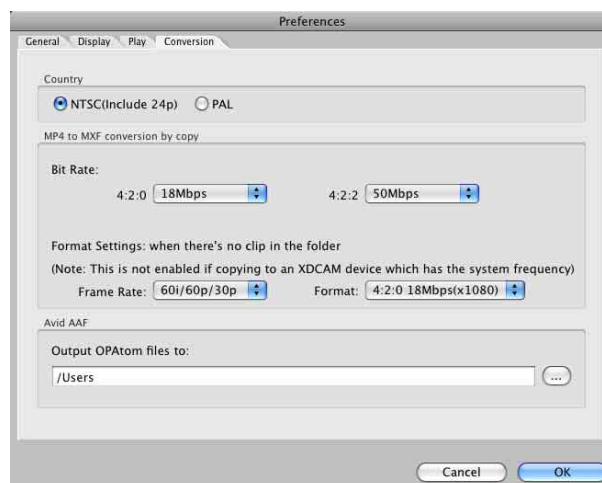

Country: Specifies the video system adopted in the region where the application is used.

- NTSC (Include 24p)
- PAL

MP4 to MXF conversion by copy: Specifies the recording format to be used at the time of file format conversion from MP4 to MXF by copy operation.

- **Bit Rate**
Specifies the bit rate of the converted file for each color format when file format conversion is performed by copy operation.
 - 4:2:0: Selects 18Mbps, 25Mbps, or 35Mbps.
 - 4:2:2: Fixed to 50Mbps.
- **Format Settings:** when there's no clip in the folder Specifies the recording format (frame rate and format) to be used when no clip exists at the copy destination during file format conversion by copy operation. The following combinations of the values can be set.

| Country | Frame Rate | Format |
|--------------------|-----------------|----------------------|
| NTSC (Include 24p) | 60i/60p/ 30p | 4:2:0 18Mbps (x1080) |
| | | 4:2:0 25Mbps (x720) |
| | | 4:2:0 25Mbps (x1080) |
| | | 4:2:0 35Mbps (x720) |
| | | 4:2:0 35Mbps (x1080) |
| | | 4:2:2 50Mbps |
| | 24p | 4:2:0 18Mbps (x1080) |
| | | 4:2:0 25Mbps (x1080) |
| | | 4:2:0 35Mbps (x1080) |
| PAL | 50i/50p/ 25p | 4:2:0 18Mbps (x1080) |
| | | 4:2:0 25Mbps (x720) |
| | | 4:2:0 25Mbps (x1080) |
| | | 4:2:0 35Mbps (x720) |
| | | 4:2:0 35Mbps (x1080) |
| | | 4:2:2 50Mbps |

For details about the file format conversion by copy operation, see page 60.

Output OPAtom files to: Specifies the output folder for OPAtom files for the [Avid AAF] subcommand of the Export command (*see next item "To set the media folder in Avid editing systems"*). Enter a path beginning with a drive name in the edit box. Or click the [...] button to open a browse dialog where you can select a folder, and then click the [OK] button.

To set the media folder in Avid editing systems

For Avid Media Composer (V2.5.3 or later), proceed as follows.

- 1** Select [Media Creation] from the [Settings] menu.

The Media Creation dialog opens.

- 2** Specify Macintosh HD as the Video Drive/Audio Drive (media storage drive) in the Import tab.
- 3** Import an MXF file into Avid Media Composer.

An "Avid Media Files/MXF/1" folder is created in the drive specified in step **2**.

Specify this folder in the [Output OPAtom files to] box.

Menu list

This section lists the menus of this application.

In the Keyboard shortcut field, the notation “Command + N” means that the N key is pressed while holding down the Command key.

| Menu | Command | Subcommand | Keyboard shortcut | Function | Reference page |
|-----------------------|------------------------------------|-----------------|----------------------|---|----------------|
| XDCAM EX Clip Browser | About XDCAM EX Clip Browser | – | – | Displays the version of this application. | – |
| | About MainConcept Conversion Packs | – | – | Displays the version of the MainConcept plug-in software. | – |
| | Preferences... | – | Command + , | Opens the Preferences dialog. | <i>Page 74</i> |
| | Services | Mac OS Commands | – | Execute various commands provided by the Mac OS. | – |
| | Hide XDCAM EX Clip Browser | – | Command + H | Hides this application. | – |
| | Hide Others | – | Option + Command + H | Hides other applications. | – |
| | Show All | – | – | Shows all applications. | – |
| | Quit XDCAM EX Clip Browser | – | Command + Q | Quits this application. | <i>Page 50</i> |

| Menu | Command | Subcommand | Keyboard shortcut | Function | Reference page | |
|-------------------------------|---------------------|------------------------|---|--|--|---------|
| File | New Explorer Window | – | – | Opens a new Explorer window. | Page 51 | |
| | New Preview Window | – | – | Opens a new Preview window. | | |
| | New Tab | – | Command + T | Adds a new tab in the active window. | – | |
| | Folder | New Folder | | Shift + Command + N | Creates a new folder in the currently selected media or folder. | Page 69 |
| | | Rename | | Option + Command + R | Renames the selected folder. | Page 70 |
| | Close Window | – | Command + W | Closes the active window. | – | |
| | Close Tab | – | – | Closes the active tab. | – | |
| | Show in Finder... | – | Command + N | Opens the selected folder in Finder, so that you can back up the folder contents. | Page 70 | |
| | Import... | – | – | Imports an MP4 file to the selected folder. | Page 63 | |
| | Export | MXF for NLEs... | – | – | Converts the selected clip to MXF format, for use on non-linear editors. | Page 64 |
| | | MXF for XDCAM HD... | – | – | Converts the selected clip to XDCAM HD format. | |
| | | MXF for XDCAM HD422... | – | – | Converts the selected clip to XDCAM HD422 format. | |
| | | XDCAM MPEG... | – | – | Converts the selected clip to XDCAM MPEG IMX format. | |
| | | XDCAM DVCAM... | – | – | Converts the selected clip to XDCAM DVCAM format. | |
| | | Raw DV... | – | – | Converts the selected clip to RAW DV format. | |
| | | AVI DV... | – | – | Converts the selected clip to AVI DV format. | |
| Avid AAF... | | – | – | Converts the selected clip to Avid AAF format. | | |
| Windows Media File... | | – | – | Converts the selected clip to Windows Media file format. | | |
| Sony PSP (H.264/AVC)... | | – | – | Converts the selected clip to a format for viewing on the PlayStation Portable (PSP) game console. | | |
| Apple iPod (H.264/AVC)... | | – | – | Converts the selected clip to a format for viewing on the Apple iPod. | | |
| Video Hosting Service... | – | – | Converts the selected clip to a format for uploading to video hosting service. | | | |
| Capture Still Image... | – | – | Creates a bitmap still picture from the frame at the current position. | Page 67 | | |
| New clip using In/Out section | – | – | Creates a new clip from the section between In and Out points of the selected clip. | Page 62 | | |

| Menu | Command | Subcommand | Keyboard shortcut | Function | Reference page | |
|-----------------------|-----------------------|----------------|--|--|--|---------|
| Edit | Cut | – | Command + X | Cuts the selected clip. | Page 61 | |
| | Copy | – | Command + C | Copies the selected clip. | Page 59 | |
| | Paste | – | Command + V | Pastes a clip that has been cut or copied. | Page 59 Page 61 | |
| | Delete | – | Command + Delete | Deletes the selected clip or folder. | Page 62 Page 70 | |
| | Copy All | – | Option + Command + C | Copies all of the clips in the selected media or folder. | Page 60 | |
| | Select All | – | Command + A | Selects all of the clips in the selected media or folder. | – | |
| | Split Folder... | – | Shift + Command + W | Splits the selected folder into folders of the specified size. | Page 71 | |
| | Combine Folders... | – | Shift + Command + J | Combines the selected folder to another specified folder. | Page 71 | |
| | Find | Find... | – | Command + F | Opens the Find dialog. | Page 68 |
| | | Start | – | – | Starts the search. | |
| | | Stop | – | – | Stops the search. | |
| | | Go to Explorer | – | – | Opens the selected clip in an Explorer window. | |
| | Edit Disc Metadata... | – | – | Opens the Edit Disc Metadata dialog. | Page 72 | |
| Special Characters... | – | – | Open the Character Palette so that you can enter special characters and symbols. | – | | |

| Menu | Command | Subcommand | Keyboard shortcut | Function | Reference page | |
|----------------------|-----------------------|----------------|--|---|--|---|
| View | Show/Hide Toolbar | – | Option + Command + T | Shows or hides the tool buttons. | Page 53 | |
| | Show/Hide Folder Tree | – | – | Shows or hides the Tree View pane. | Page 53 | |
| | Up | – | Command + ↑ | Moves up one level in the folder hierarchy. | – | |
| | Thumbnails | – | – | Puts the List View pane into thumbnail view mode. | Page 54 | |
| | Details | – | – | Puts the List View pane into details view mode. | | |
| | Sort By | Clip Name | – | – | Sorts the clip list on the selected key, in ascending or descending order. | – |
| | | Size | – | | | |
| | | Duration | – | | | |
| | | Status | – | | | |
| | | Creation Date | – | | | |
| | | Last Update | – | | | |
| | | Rec Mode | – | | | |
| | | Media Spanning | – | | | |
| | | Folder Path | – | | | |
| Save sort order | – | – | Saves the current sort order for the current folder. | – | | |
| Customize Columns... | – | – | – | Opens the Customize Columns dialog. | Page 55 | |
| Message Options | Reset to the default | – | – | Subsequently displays the message box which was set to be hidden by the setting of the [Do not show this message in the future.] check box. | – | |
| Refresh | – | – | – | Refreshes the information displayed in the active tab of the Explorer window. | – | |
| Full Screen | – | – | Option + Return | Puts the Viewer into Full Screen mode. | Page 56 | |

| Menu | Command | Subcommand | Keyboard shortcut | Function | Reference page | |
|-----------------------|-----------------------|-------------------|--------------------------------------|--|--|----------------|
| Preview | Play | – | L or Space | Plays the selected clip. | <i>Page 66</i> | |
| | Stop | – | K or Space | Stops clip play. | | |
| | Play Reverse | – | J | Plays the selected clip in the reverse direction. | | |
| | Play In to Out | – | Shift + Space | Plays the range from the In point to the Out point of the selected clip. | | |
| | –1 Frame | – | ← | Steps one frame back. | | |
| | +1 Frame | – | → | Steps one frame forward. | | |
| | Jump to Start | – | Home | Jumps to the clip start point (first frame). | | |
| | Jump to End | – | End | Jumps to the clip end point (last frame). | | |
| | Jump to In Point | – | ↑ | Jumps to the In point. | | |
| | Jump to Out Point | – | ↓ | Jumps to the Out point | | |
| | Previous Essence Mark | – | Shift + ← | Jumps to the previous essence mark. | | |
| | Next Essence Mark | – | Shift + → | Jumps to the next essence mark. | | |
| | Edit | Set Index Picture | | P | Sets the frame at the current position as the index picture. | <i>Page 67</i> |
| | | Mark In | | I | Sets an In point at the current position. | <i>Page 62</i> |
| Mark Out | | | O | Sets an Out point at the current position. | | |
| Clear Mark In | | | Shift + I | Clears the In point. | | |
| Clear Mark Out | | | Shift + O | Clears the Out point. | | |
| Clear Mark In/Out | | | Shift + X | Clears the In and Out points. | | |
| Add Essence Mark | | | E | Sets an essence mark at the current position (up to 126). | – | |
| Delete Essence Mark | | | Shift + E | Deletes the essence mark at the current position. | – | |
| Edit Essence Marks... | | | – | Opens the Edit Essence Marks dialog. | <i>Page 67</i> | |
| Set Audio Channels... | – | – | Opens the Set Audio Channels dialog. | <i>Page 66</i> | | |
| Window | Previous Tab | – | Shift + Command + { | Selects the previous tab. | <i>Page 52</i> | |
| | Next Tab | – | Shift + Command + } | Selects the next tab. | | |
| | Minimize | – | Command + M | Minimizes the active window. | – | |
| | Zoom | – | – | Maximizes the active window or returns it to its original size. | – | |
| | Bring All to Front | – | – | Brings all the currently open windows to the front of the screen. | – | |

Error and warning message list

| Messages | What to do |
|--|---|
| Failed to initialize OLE. Please confirm whether the OLE library version is correct. | There may be a problem with the installation of this application. Try installing it again. |
| Failed to read libraries for Export. | |
| The folder contains some incomplete clips. Please copy all files in the [BPAV] folder under the selected folder to an SxS card and execute salvage operation on the recording equipment. | Data on the media is incomplete, probably because the XDCAM EX device was powered off during recording, or because the media was ejected prematurely. Return the media to the XDCAM EX device and salvage it immediately. The data may become unrecoverable if you continue to operate without salvaging it. |
| Incomplete clip exists. Please execute salvage operation on the recording equipment. | |
| Reason: The clip database is incorrect. | The XDCAM EX format may be corrupt. Try to salvage the material, for example by importing an MP4 file to another folder. |
| The clip cannot be displayed in Explorer. | Check the properties of the selected clip. It cannot be imported or displayed in the list because the format is not compatible with the XDCAM EX format. |
| Failed to save sort order. | Try restarting this application, or restarting the computer. If the problem persists, install the application again. |
| The clip database is incorrect, so it cannot be copied. | The XDCAM EX format may be corrupt. Try to salvage the material, for example by importing an MP4 file to another folder. |
| The clip database is incorrect, so it cannot be moved. | |
| Failed to update properties. | |
| A file exceeding 4 GB needs to be split, so the file cannot be copied. | Files larger than 4 GB cannot be managed on media like the SxS memory cards used by XDCAM EX devices. Use editing software or some other tool to split the file into files smaller than 4 GB and then try again. |
| A file exceeding 4 GB needs to be split, so the file cannot be moved. | |
| Failed to create a clip. | The operation was cancelled for one of the following reasons. <ul style="list-style-type: none"> You do not have delete and write privileges to the selected media or folder, or these operations are inhibited. The data is in an incompatible format, or it is corrupt. Check the properties of the media or folder. |
| Reason: Unmatched frame rate. | The selected clip cannot be copied due to difference in frame rate between that clip and clips existing in the copy destination folder. Check the frame rate (NTSC/24p/PAL) of the clip you want to copy and then perform copy by selecting a destination folder in which all the existing clips are of the same frame rate as the selected clip. |
| Reason: The video format is different. | The selected clip cannot be copied due to difference in resolution between that clip and clips existing in the copy destination folder. Check the resolution of the clip that you want to copy and then perform copy by selecting a destination folder in which all the existing clips are of the same resolution as the selected clip. |
| Reason: Default format hasn't been set. Please check Conversion tab in Preferences. | Set the frame rate and bit rate in the [Rates to apply when rec format is unknown] section of the Conversion tab in the Preferences dialog. |
| Reason: Bit Rate hasn't been set. Please check Conversion tab in Preferences. | Make settings in the [MP4 to MXF conversion bit rate] section of the Conversion tab in the Preferences dialog. |
| Reason: Failed to convert. | Check the recording format of the clip that you want to copy and that of the clips existing in the copy destination folder. File conversion may be disabled depending on the recording format of the original clip and the clips in the copy destination folder. |
| Reason: The clip is less than 2 seconds, so it cannot be written. | XDCAM devices do not support writing of clips shorter than two seconds. |
| It cannot be copied because a Clip less than 2 seconds is included. | |

| Messages | What to do |
|---|--|
| UserData folder cannot be specified as the destination to copy MXF files. Please change the Copy All destination in Preferences. | Change the setting in [Copy all files to:] of the General tab in the Preferences dialog. |
| Failed to import the clip. | Check the properties of the clip. You may not have access privileges to the clip, or the clip may be an MP4 file that is not compatible with the XDCAM EX format. |
| UserData folder cannot be specified as the output destination. | Change the output destination. |
| UserData folder cannot be specified as the destination to output OPAtom files. Please change the OPAtom file output destination in Preferences. | Change the setting in [Output OPAtom files to:] of the Conversion tab in the Preferences dialog. |
| The name is already used. Please specify other name. | Specify other name or change the output destination. |
| Error occurred during the export. Please refer to the details from the context on each clip. | Open the export dialog to check the report which is displayed when [Error detail] is selected from the context menu of the clip with the error. |
| Reason: An error occurred during conversion. | The conversion failed for one of the following reasons. <ul style="list-style-type: none"> You do not have delete and write privileges to the output folder, or these operations are inhibited. The selected clip is in an unsupported format, or the material data is corrupt. Check the properties of the folder and clip. |
| Reason: Unsupported XDCAM. | The selected XDCAM drive is not supported. |
| Reason: Unsupported codec. | The codec of the selected clip on the XDCAM drive is not supported. |
| Failed to create a folder. | Check the properties of the selected media or folder. You may not have delete and write privileges to the media or folder, or these operations may be inhibited. |
| You cannot use [XXX] as a folder name. Please specify another name. | Specify a name other than "BPAV". |
| It contains a string reserved by the system, so it cannot be set. | The name contains characters reserved by the operating system. Enter a name that does not contain these characters. |
| Reason: The clip file name has already been reserved. | Change the file name or copy destination. |
| A name beginning with a dot (.) is used by the system only. Please give other name for User Disc ID. | Specify other name. |
| Failed to change the folder name. | Check the properties of the selected folder. You may not have delete and write privileges to the folder, or these operations may be inhibited. |
| Failed to delete the folder. | |
| Failed to split the folder. | |
| Failed to combine the folders. | Check the properties of the combine source or destination folder. You may not have delete and write privileges to these folders, or these operations may be inhibited. |
| [XXX] contains a work folder, so it cannot be deleted. | The selected media or folder contains one or more folders that are not under the management of this application. Delete or move these folders and then try again. |
| Reason: [XXX] has a sub folder. | |
| The folder [XXX] cannot be split. Reason: The folder contains a file exceeding the specified split unit of [XXX GB]. Clip name: | The folder cannot be split into folders of the specified size because at least one file larger than that size exists. Specify a split size that is larger than the size of the largest file. |
| Failed to save disc metadata. | Check the properties of the selected XDCAM drive and the state of the write protect tab on the disc. You may not have delete and write privileges for the selected XDCAM drive, or these operations may be inhibited. |

How to obtain the plug-in software

The optional MainConcept plug-in software can be purchased and downloaded from the following website.
<http://www.mainconcept.com/plugin4clipbrowser>

Licenses

MPEG-4 Visual Patent Portfolio License

THIS PRODUCT IS LICENSED UNDER THE MPEG-4 VISUAL PATENT PORTFOLIO LICENSE FOR THE PERSONAL AND NONCOMMERCIAL USE OF A CONSUMER FOR

- (i) ENCODING VIDEO IN COMPLIANCE WITH THE MPEG-4 VISUAL STANDARD (“MPEG-4 VIDEO”) AND/OR
- (ii) DECODING MPEG-4 VIDEO THAT WAS ENCODED BY A CONSUMER ENGAGED IN A PERSONAL AND NON-COMMERCIAL ACTIVITY AND/OR WAS OBTAINED FROM A VIDEO PROVIDER LICENSED BY MPEG LA TO PROVIDE MPEG-4 VIDEO.

NO LICENSE IS GRANTED OR SHALL BE IMPLIED FOR ANY OTHER USE.

ADDITIONAL INFORMATION INCLUDING THAT RELATING TO PROMOTIONAL, INTERNAL AND COMMERCIAL USES AND LICENSING MAY BE OBTAINED FROM MPEG LA, LLC. SEE [HTTP://WWW.MPEGLA.COM](http://WWW.MPEGLA.COM)

MPEG LA is offering licenses for (i) manufacturing/sales of any storage media storing MPEG-4 Visual video information (ii) distribution/broadcasting of MPEG-4 Visual video information in any manner (such as online video distribution service, internet broadcasting, TV broadcasting). Other usage of this product may be required to obtain license from MPEG LA. Please contact MPEG LA for any further information. MPEG LA, L.L.C., 250 STEELE STREET, SUITE 300, DENVER, COLORADO 80206, <http://www.mpegla.com>

MPEG-2 Video Patent Portfolio License

ANY USE OF THIS PRODUCT OTHER THAN CONSUMER PERSONAL USE IN ANY MANNER THAT COMPLIES WITH THE MPEG-2 STANDARD FOR ENCODING VIDEO INFORMATION FOR PACKAGED MEDIA IS EXPRESSLY PROHIBITED WITHOUT A LICENSE UNDER APPLICABLE PATENTS IN THE MPEG-2 PATENT PORTFOLIO, WHICH LICENSE IS AVAILABLE FROM MPEG LA, L.L.C., 250 STEELE STREET, SUITE 300, DENVER, COLORADO 80206.

AVC Patent Portfolio License

THIS PRODUCT IS LICENSED UNDER THE AVC PATENT PORTFOLIO LICENSE FOR THE PERSONAL AND NON-COMMERCIAL USE OF A CONSUMER TO

- (i) ENCODE VIDEO IN COMPLIANCE WITH THE AVC STANDARD (“AVC VIDEO”) AND/OR
 - (ii) DECODE AVC VIDEO THAT WAS ENCODED BY A CONSUMER ENGAGED IN A PERSONAL AND NON-COMMERCIAL ACTIVITY AND/OR WAS OBTAINED FROM A VIDEO PROVIDER LICENSED TO PROVIDE AVC VIDEO.
- NO LICENSE IS GRANTED OR SHALL BE IMPLIED FOR ANY OTHER USE. ADDITIONAL INFORMATION MAY BE OBTAINED FROM MPEG LA, L.L.C. SEE [HTTP://WWW.MPEGLA.COM](http://WWW.MPEGLA.COM)

VC-1 Patent Portfolio License

THIS PRODUCT IS LICENSED UNDER THE VC-1 PATENT PORTFOLIO LICENSE FOR THE PERSONAL AND NON-COMMERCIAL USE OF A CONSUMER TO

- (i) ENCODE VIDEO IN COMPLIANCE WITH THE VC-1 STANDARD (“VC-1 VIDEO”) AND/OR
- (ii) DECODE VC-1 VIDEO THAT WAS ENCODED BY A CONSUMER ENGAGED IN A PERSONAL AND NON-COMMERCIAL ACTIVITY AND/OR WAS OBTAINED FROM A VIDEO PROVIDER LICENSED TO PROVIDE VC-1 VIDEO.

NO LICENSE IS GRANTED OR SHALL BE IMPLIED FOR ANY OTHER USE. ADDITIONAL INFORMATION MAY BE OBTAINED FROM MPEG LA, L.L.C. SEE [HTTP://WWW.MPEGLA.COM](http://WWW.MPEGLA.COM)

